

**poalgi** | KITCHEN



# El corazón del hogar

La cocina es el corazón del hogar, allí donde todo sucede: cocinamos, comemos, debatimos, jugamos, planeamos. Cada cocina es un mundo independiente, un epicentro de vida y acontecimientos de gran importancia en nuestra cotidianidad. Punto de encuentro y disfrute, las cocinas han cambiado y, acorde a la lozanía de su función, también su diseño, cada vez más personalizado, abierto y conectado con el hogar. Los fregaderos de cocina Poalgi atienden a esa nueva concepción con diseños que siguen el pulso de la vida. Sus materiales inteligentes logran una resistencia a prueba del tiempo. La personalización de su paleta cromática es la horma del diseño de interiores. Su funcionalidad, su textura y la naturalidad de sus formas convierten su uso en deleite.

Home is where the heart is.

The kitchen is the heart of the home, where everything happens; we cook, we eat, we congregate, we debate, we play, we plan. Each kitchen is an independent world, an epicentre of vibrant life and events of great importance throughout our daily lives. As a meeting place and a place of enjoyment, kitchens have evolved in line with the freshness of their function, and ultimately their design, a place which has become increasingly personalised, open and connected to the home.

Poalgi Kitchen Sinks respond to this conceptual innovation with designs that follow the pulse of life. Our intelligent materials achieve a resistance that stands the test of time. The customisation of our colour palette is the ultimate in interior design. The functionality of our product, its texture and the naturalness of shape and form turn its utility into sheer delight.

Le cœur de la maison.

La cuisine est le cœur de la maison, là où tout se passe : on cuisine, on mange, on discute, on joue, on planifie. Chaque cuisine est un monde indépendant, un épiceutre de vie et d'événements de grande importance dans notre quotidien. Point de rencontre et de plaisir, les cuisines ont changé et sont, selon la fraîcheur de leur fonction ainsi que leur conception, de plus en plus personnalisées, ouvertes et connectées à la maison.

Les évier de cuisine Poalgi répondent à cette nouvelle conception avec des conceptions qui suivent le pouls de la vie. Leurs matériaux intelligents résistent à l'épreuve du temps. La personnalisation à travers leur éventail chromatique est un atout dans le design d'intérieur. Leur fonctionnalité, leur texture et le naturel de leurs dessins rendent leur utilisation très plaisante.







# Fregaderos hechos para la vida

Las colecciones de fregaderos Poalgi se conciben -y crean- como piezas de artesanía cuidadosamente proyectadas y llevadas a término. El saber hacer de la tradición ceramista se conjuga con las nuevas tecnologías aplicadas al diseño y la fabricación para crear fregaderos funcionales, resistentes y bellos, hechos para la vida. La personalización cromática y los acentos estéticos de cada colección ofrecen una variedad de modelos capaces de armonizar y avivar el diseño de cualquier cocina.

Sinks made for life.

Poalgi Sink collections are conceived and created as pieces of craftsmanship carefully planned and brought to completion. The 'know-how' of the ceramic tradition is combined with new technologies applied to design and manufacture to create functional, resistant, and beautiful sinks, made for life.

The chromatic customisation and aesthetic accents of each collection offer a variety of models capable of harmonising and enlivening the design of any kitchen.

Des éviers faits pour la vie.

Les collections d'éviers Poalgi sont pensées - et créées- comme des pièces d'artisanat soigneusement conçues et réalisées. Le savoir-faire de la tradition céramiste se conjugue avec les nouvelles technologies appliquées au design et à la fabrication pour créer des éviers fonctionnels, résistants et beaux, faits pour la vie.

La personnalisation chromatique et les particularités esthétiques de chaque collection offrent une variété de modèles capables d'harmoniser et d'animer le design de toute cuisine.







# 1



12

kobus collection	20
zie collection	36
gandia collection	58
city collection	74

# 2



88

zie collection	100
gandia collection	118
shira collection	132
city collection	150
kuma collection	162
basic collection	176

# Index

3	ACCESSORIES	184
---	-------------	-----



4	USO Y MANTENIMIENTO	194
5	ACABADOS	198
6	MATERIALES	200
7	INFORMACIÓN COMERCIAL	203
8	CLASIFICACIÓN POR MUEBLE	206
9	ÍNDICE DE PRODUCTO	208

**HEKLA<sup>®</sup>**  
poalgi

**Fregaderos en masa**  
**Granite kitchen sinks**  
Evers de masse





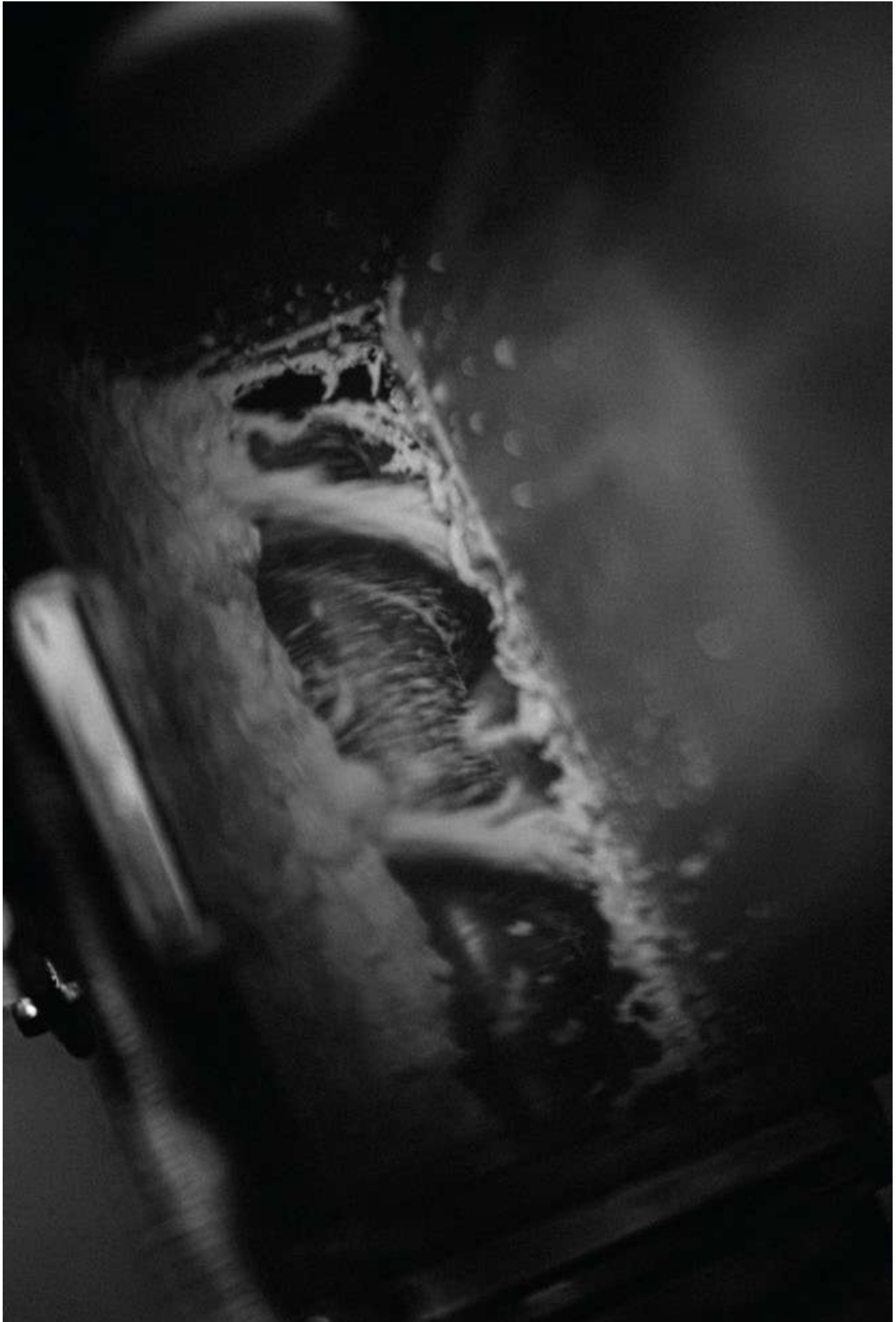





Hekla® es el nuevo material en masa de Poalgi. Un material para resistir al paso del tiempo creado mediante un proyecto de investigación y desarrollo liderado por nuestro ambicioso equipo, avalado por el Instituto Tecnológico AIDIMME.

Inspirado en la bravura de los volcanes, Hekla® es un material compacto compuesto por cargas minerales en diferentes granulometrías que, junto con la resina técnica añadida, envuelven cada partícula logrando un material único y resistente.

La tecnología de última generación empleada en la elaboración de los productos Hekla® garantiza la resistencia bajo carga, el daño de impactos y los efectos de las altas y bajas temperaturas, así como la seguridad del transporte, instalación y el uso diario.

Su tratamiento en superficie evita la aparición de bacterias, y su tratamiento V (de antienviejecimiento) hace cada producto Hekla® superviviente al paso del tiempo.

Hekla® Poalgi's new mass material of homogeneous composition. A material developed to resist the passage of time. Created through an R & D project led by our ambitious team, and also endorsed by the AIDIMME Technological Institute.

Inspired by the energy and endurance of volcanoes, Hekla® is a compact material composed of mineral charges in variable granulometric forms, together with the added technical resin, envelope each particle to achieve a unique and highly resistant material.

Our 'State of the Art Technology' used in the production of Hekla® products guarantees resistance under load, impact damage and the effects of high and low temperatures, as well as safety during transportation, installation and daily use. Its surface treatment prevents the growth of bacteria and its V (anti-ageing) treatment makes every Hekla® product a champion over time.

Hekla® est le nouveau matériau de masse de Poalgi. Un matériau pour résister au passage du temps créé par un projet de recherche et développement dirigé par notre équipe ambitieuse, et approuvé par l'Institut Technologique AIDIMME.

Inspiré par la bravoure des volcans, Hekla® est un matériau compact composé de charges minérales dans différentes granulométries qui, avec la résine technique ajoutée, enveloppent chaque particule en obtenant un matériau unique et résistant.

La technologie de dernière génération utilisée dans la fabrication des produits Hekla® garantit la résistance à la charge, les dommages d'impact et les effets des températures élevées et basses, ainsi que la sécurité du transport, de l'installation et de l'utilisation quotidienne.

Son traitement de surface empêche l'apparition de bactéries et son traitement V (anti-vieillessement) rend chaque produit Hekla® en un véritable survivant au passage du temps.





Resistencia al rayado, calor, abrasión, agentes químicos y colorantes. Material antibacteriano.

Resistance against scratching, abrasion, bacteria, heat, chemical agents and colourings

Résistance aux rayures, abrasion, bactéries, fortes températures, agents chimiques, colorants.



# 01 kobus collection

**Robusto y a la vez tan delicado, como las grandes almas. El fregadero Kobus es nobleza y hogar, sin artificios. Comodidad, elegancia y resistencia. Fabricado en nuestro material en masa, nos otorga una amplia y confortable zona de trabajo resistente a todos los factores externos.**

Robust while at the same time both delicate and soulful. The Kobus sink is nobility and honour at home, without artifice. Comfort, elegance and durability. Made of our mass material, it provides a spacious and comfortable working area that is resistant to all external factors.

Robuste et à la fois aussi délicat que les grandes âmes. L'évier Kobus est noblesse et confort, sans artifices. Aisance, élégance et endurance. Fabriqué dans notre matériau de masse, cela nous confère une zone de travail large et confortable résistante à tous les facteurs externes.

## **Características** \_Characteristics \_Caractéristiques

Hekla®	Antibacteriano	Textura pizarra	Sobre encimera
Hekla®	Antibacterial	Slate texture	Inset
Hekla®	Antibactérien	Texture ardoise	Sur plan de travail





Snow Kobus 812 Sink  
Artic White Neolith Counter  
Walnut finish Magama  
Furniture





# kobus<sub>\_812</sub>



KOBUS Ref. 812 Color SW\_Snow Slate\_Texture

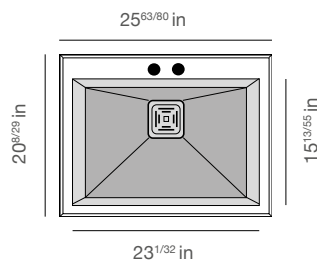
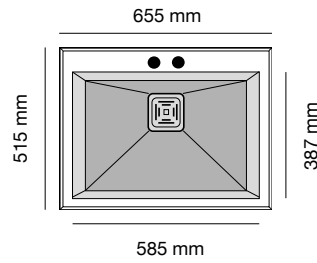

# kobus<sub>\_813</sub>

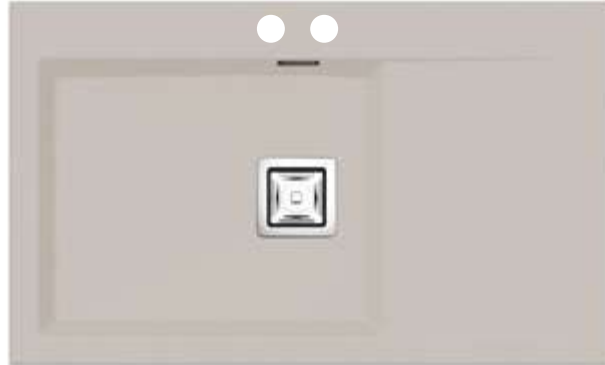

KOBUS Ref. 813D Color PU\_Pumice Slate\_Texture

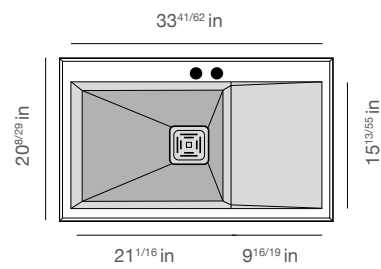
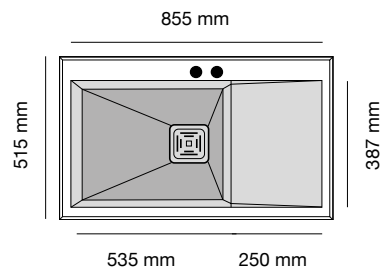



Pumice Kobus 813 Sink  
Artic White Neolith Counter  
Glazed Walnut finish  
Magama Furniture







Ash Kobus 826 Sink  
Zaha Stone Neolith Counter  
Walnut finish Magama  
Furniture

# kobus<sub>\_826</sub>

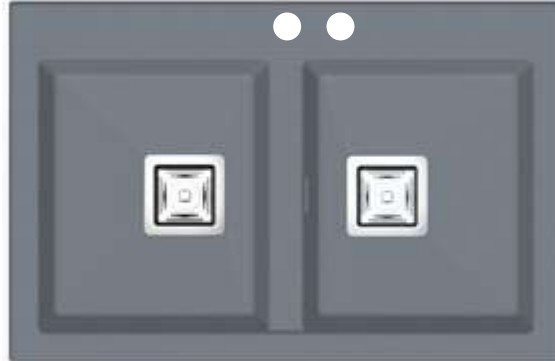

KOBUS Ref. 826 Color AS\_Ash Slate\_Texture

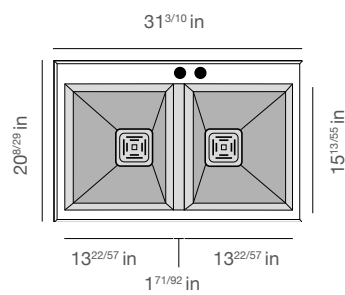
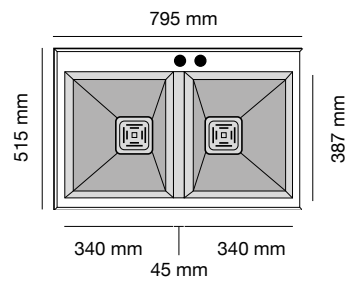

# kobus<sub>\_821</sub>



KOBUS Ref. 821 Color BS\_Basalt Slate\_Texture

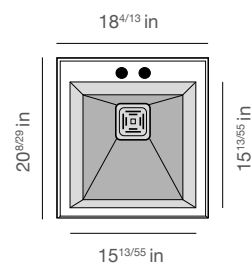
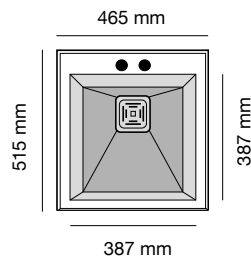





Basalt Kobus 821 Sink  
Unique Marquina Compac  
Counter  
Glazed Walnut finish  
Magama Furniture

# 01 kobus collection

<b>Modelo</b>	Ref. 811_ 5 cm_ 0,20 in	Ref. 812_ 5 cm_ 0,20 in	Ref. 813D_ 5 cm_ 0,20 in / 823D_ 1,5 cm_ 0,06 in
<b>Model</b>	Ref. 821_ 1,5 cm_ 0,06 in	Ref. 822_ 1,5 cm_ 0,06 in	Ref. 813L_ 5 cm_ 0,20 in / 823L_ 1,5 cm_ 0,06 in
<b>Modèle</b>			

<b>Medidas</b> Measurements Mesures	<p>465 mm 18<sup>4</sup>/<sub>13</sub> in</p> <p>515 mm 20<sup>8</sup>/<sub>29</sub> in</p> <p>387 mm 15<sup>13</sup>/<sub>55</sub> in</p>	<p>655 mm 25<sup>63</sup>/<sub>80</sub> in</p> <p>515 mm 20<sup>8</sup>/<sub>29</sub> in</p> <p>585 mm 23<sup>1</sup>/<sub>32</sub> in</p>	<p>855 mm 33<sup>41</sup>/<sub>62</sub> in</p> <p>515 mm 20<sup>8</sup>/<sub>29</sub> in</p> <p>535 mm 21<sup>1</sup>/<sub>16</sub> in</p> <p>250 mm 9<sup>16</sup>/<sub>19</sub> in</p>
---	--	--	--

<b>Profundidad cubeta</b>	200 mm	200 mm	200 mm
<b>Bucket depth</b>	7 <sup>7</sup> / <sub>8</sub> in	7 <sup>7</sup> / <sub>8</sub> in	7 <sup>7</sup> / <sub>8</sub> in
<b>Profondeur de la cuve</b>			

<b>Encastre Sobre encimera</b> Inset Sous plan de travail	<p>448 mm. 17<sup>37</sup>/<sub>58</sub> in</p> <p>500 mm. 19<sup>37</sup>/<sub>54</sub> in</p>	<p>640 mm. 25<sup>13</sup>/<sub>68</sub> in</p> <p>500 mm. 19<sup>37</sup>/<sub>54</sub> in</p>	<p>840 mm. 33<sup>1</sup>/<sub>14</sub> in</p> <p>500 mm. 19<sup>37</sup>/<sub>54</sub> in</p>
---	---	---	--

<b>Mueble</b>	45 cm	70 cm	60 cm
<b>Furniture</b>	1 <sup>71</sup> / <sub>92</sub> in	2 <sup>65</sup> / <sub>86</sub> in	2 <sup>25</sup> / <sub>69</sub> in
<b>Meuble</b>			

<b>Paquete</b>	540 x 580 x 310 mm	720 x 580 x 310 mm	920 x 580 x 310 mm
<b>Packaging</b>	15,6 kg (811) / 14,9 kg (821)	18,5 kg (812) / 17 kg (822)	22 kg (813) / 20 kg (823)
<b>Colis</b>	21 <sup>13</sup> / <sub>50</sub> x 22 <sup>5</sup> / <sub>6</sub> x 12 <sup>17</sup> / <sub>83</sub> in	28 <sup>9</sup> / <sub>26</sub> x 22 <sup>5</sup> / <sub>6</sub> x 12 <sup>17</sup> / <sub>83</sub> in	35 <sup>13</sup> / <sub>59</sub> x 22 <sup>5</sup> / <sub>6</sub> x 12 <sup>17</sup> / <sub>83</sub> in

<b>Tarifa</b>	340 €	380 €	415 €
<b>Price</b>			
<b>Tarif</b>			

**Acabados**  
Finishes  
Finition



Los precios no incluyen IVA. Esta tarifa anula las anteriores.  
 Prices do not include VAT. This price list cancel and substitute the previous ones.  
 Les prix ne comprennent pas la TVA. Ce taux annule les précédents.

Ref. 814\_ 5 cm\_ 0,20 in  
 Ref. 824\_ 1,5 cm\_ 0,06 in

Ref. 816\_ 5 cm\_ 0,20 in  
 Ref. 826\_ 1,5 cm\_ 0,06 in

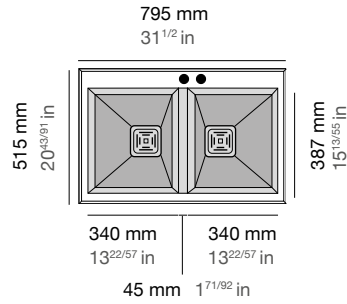
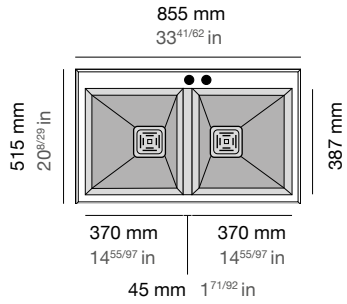

200 mm  
 7 7/8 in

200 mm  
 7 7/8 in

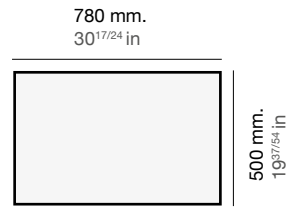
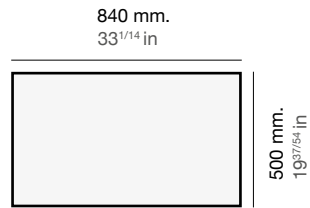

90 cm  
 3 25/46 in

80 cm  
 3 3/20 in

920 x 580 x 310 mm  
 26,5 kg (814) / 24 kg (824)  
 36 13/59 x 22 5/6 x 12 17/83 in

860 x 580 x 310 mm  
 26 kg (816) / 23,5 kg (826)  
 33 8/7 x 22 5/6 x 12 17/83 in

505 €

470 €

Incluye  
 Includes  
 Inclus

Válvula cuadrada automática.  
 Sifón y sellante.  
 Plantillas de encastre.

Square Automatic valve.  
 Siphon and sealant.  
 Template inlay.

Vanne automatique carrée.  
 Siphon et le colle mastic.  
 Le gabarit d'encastrement.

KITCHEN



## 02 zie collection

Sofisticación y modernidad, el fregadero Zie es un canto a la discreción. La síntesis de un nuevo estilo de cocina basado en líneas puras, la exención de lo superfluo y la integración de sus elementos. Diseñado para mimetizarse con su encimera gracias a su forma, Zie es minimalismo puro.

Sophistication and modernity, the Zie sink is an ode to discretion. The synthesis of a new kitchen style based on pure lines, the exemption of the superfluous and the integration of its elements. Designed to blend in with its worktop thanks to its shape, Zie is pure minimalism.

Sophistication et modernité, l'évier Zie est un chant à la discrétion. La synthèse d'un nouveau style de cuisine basé sur des lignes pures, l'exemption du superflu et l'intégration de ses éléments. Conçu pour se fondre dans le plan de travail grâce à sa forme, Zie est pur minimalisme.

### **Características** \_Characteristics \_Caractéristiques

Hekla	Antibacteriano	Bajo encimera	Sobre encimera
Hekla	Antibacterial	Undermount	Inset
Hekla	Antibactérien	Sous plan de travail	Sur plan de travail



Basalt Zie 185 Sink  
Nocturnal Eros Compac  
Counter  
Walnut finish Magama  
Furniture





zie<sub>81</sub>



ZIE\_81 1C + Esc Ref. 185 Color BS\_Basalt

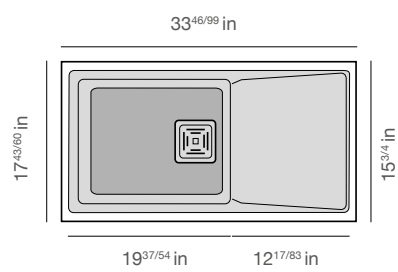
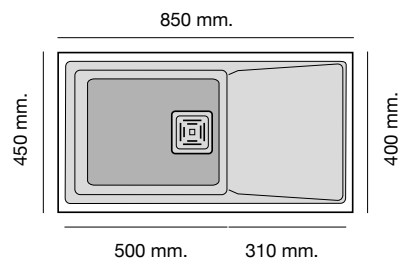

zie<sub>45</sub>



ZIE\_45 Ref. 181 Color AS\_ASH

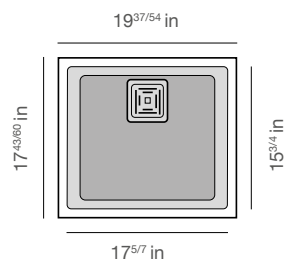
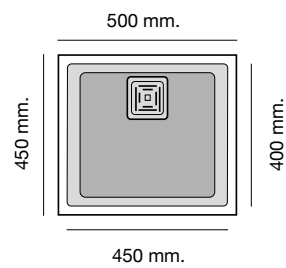

Ash Zie 181 Sink  
Unique Argento Compac  
Counter  
Glazed Walnut finish  
Magama Furniture





Snow Zie 183 Sink  
Unique Calacatta Compac  
Counter  
White finish Magama  
Furniture





zie<sub>\_70\_1C<sup>1/2</sup></sub>



ZIE\_70\_1<sup>1/2</sup>C Ref. 183 Color SW\_Snow

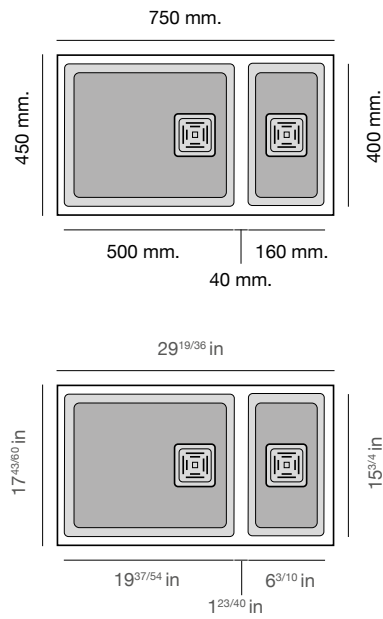

zie<sub>60</sub>



ZIE\_60 Ref. 182 Color PU\_Pumice

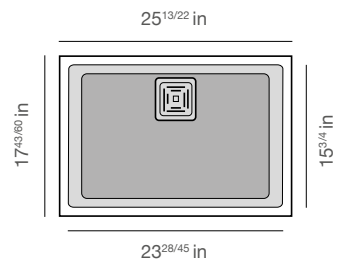
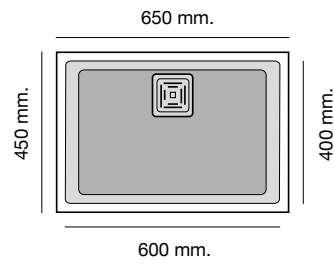



Pumice Zie 182 Sink  
Retrostone Neolith Counter  
Walnut finish Magama  
Furniture



zie<sub>50</sub>



ZIE\_50 Ref. 186 Color AS\_Ash

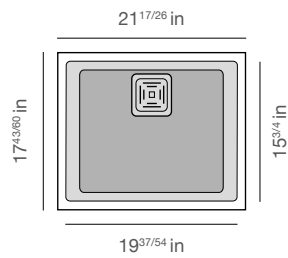
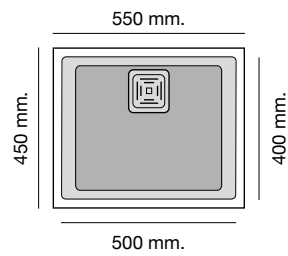



Snow Zie 184 Sink  
Unique Calacatta Compac  
Counter  
Walnut finish Magama  
Furniture



# zie<sub>70 2C</sub>

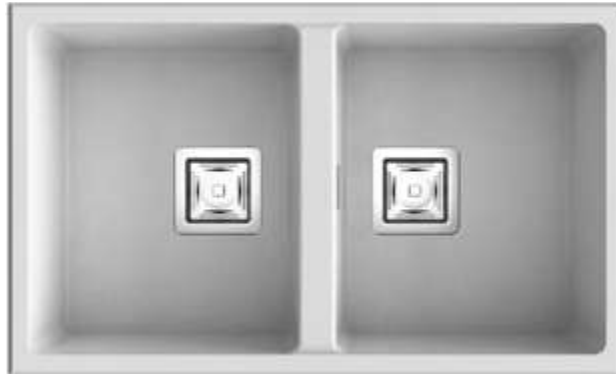

ZIE\_70\_2C Ref. 184 Color SW\_Snow

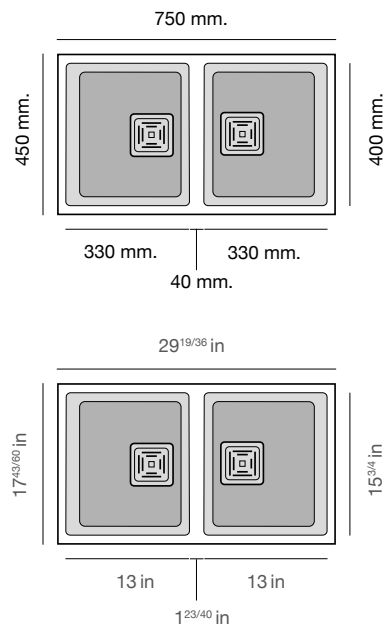

zie<sub>70</sub>



ZIE\_70 Ref. 187 Color BS\_Basalt

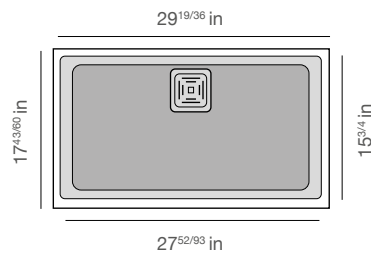
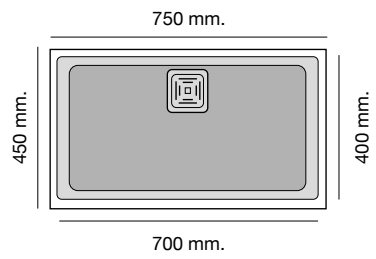



# 02 zie collection

Modelo	ZIE_45 Ref. 181	ZIE_50 Ref. 186	ZIE_60 Ref. 182	ZIE_70 1C Ref. 187
Model				
Modèle				

Medidas Measurements Mesures	<p>500 mm. 19<sup>37/54</sup> in</p> <p>450 mm. 17<sup>5/7</sup> in</p>	<p>550 mm. 21<sup>17/26</sup> in</p> <p>450 mm. 19<sup>37/54</sup> in</p>	<p>650 mm. 25<sup>13/22</sup> in</p> <p>450 mm. 23<sup>28/45</sup> in</p>	<p>750 mm. 29<sup>19/36</sup> in</p> <p>450 mm. 27<sup>52/93</sup> in</p>
------------------------------------	---	---	---	---

Profundidad cubeta Bucket depth Profondeur de la cuve	200 mm 7 <sup>7/8</sup> in	200 mm 7 <sup>7/8</sup> in	200 mm 7 <sup>7/8</sup> in	200 mm 7 <sup>7/8</sup> in
---	-------------------------------	-------------------------------	-------------------------------	-------------------------------

Sobre encimera Inset Sous plan de travail	<p>485 mm. 19<sup>5/53</sup> in</p> <p>435 mm. 17<sup>1/8</sup> in</p>	<p>535 mm. 21<sup>1/16</sup> in</p> <p>435 mm. 17<sup>1/8</sup> in</p>	<p>635 mm. 25 in</p> <p>435 mm. 17<sup>1/8</sup> in</p>	<p>735 mm. 28<sup>15/16</sup> in</p> <p>435 mm. 17<sup>1/8</sup> in</p>
---	--	--	---	---

Mueble Furniture Meuble	50 cm 1 <sup>31/32</sup> in	60 cm 2 <sup>25/69</sup> in	70 cm 2 <sup>65/86</sup> in	80 cm 3 <sup>3/20</sup> in
-------------------------------	--------------------------------	--------------------------------	--------------------------------	-------------------------------

Bajo encimera Undermount Sur plan de travail	<p>445 mm. 17<sup>13/25</sup> in</p> <p>395 mm. 15<sup>43/78</sup> in</p>	<p>495 mm. 19<sup>21/43</sup> in</p> <p>395 mm. 15<sup>43/78</sup> in</p>	<p>595 mm. 23<sup>37/87</sup> in</p> <p>395 mm. 15<sup>43/78</sup> in</p>	<p>695 mm. 27<sup>25/69</sup> in</p> <p>395 mm. 15<sup>43/78</sup> in</p>
--	---	---	---	---

Mueble Furniture Meuble	60 cm 2 <sup>25/69</sup> in	60 cm 2 <sup>25/69</sup> in	70 cm 2 <sup>65/86</sup> in	80 cm 3 <sup>3/20</sup> in
-------------------------------	--------------------------------	--------------------------------	--------------------------------	-------------------------------

Paquete Packaging Colis	610 x 510 x 300 mm 12,5 kg	680 x 510 x 300 mm 13,5 kg	710 x 510 x 300 mm 14 kg	850 x 510 x 300 mm 17,5 kg
	24 <sup>1/64</sup> x 20 <sup>7/89</sup> x 11 <sup>73/90</sup> in	26 <sup>71/92</sup> x 20 <sup>7/89</sup> x 11 <sup>73/90</sup> in	27 <sup>20/21</sup> x 20 <sup>7/89</sup> x 11 <sup>73/90</sup> in	33 <sup>46/99</sup> x 20 <sup>7/89</sup> x 11 <sup>73/90</sup> in

Tarifa Price Tarif	315 €	325 €	345 €	365 €
--------------------------	-------	-------	-------	-------

Acabados Finishes Finition				
	SNOW	PUMICE	ASH	BASALT



Los precios no incluyen IVA. Esta tarifa anula las anteriores.  
 Prices do not include VAT. This price list cancel and substitute the previous ones.  
 Les prix ne comprennent pas la TVA. Ce taux annule les précédents.

ZIE\_70 1<sup>1/2</sup>C. Ref. 183

ZIE\_70 2C. Ref. 184

ZIE\_81 Ref. 185

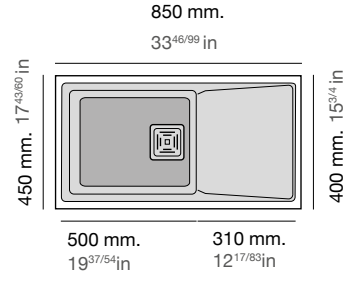
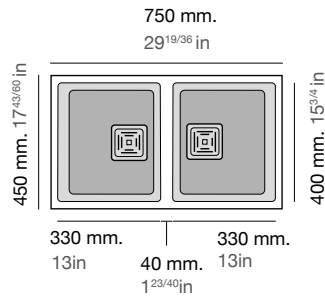
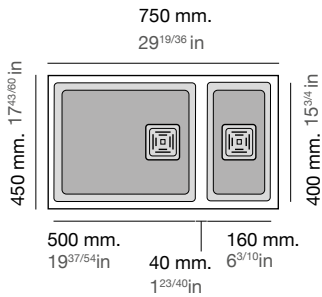

200 mm + 150 mm  
7<sup>7/8</sup> + 5<sup>48/53</sup> in

200 mm  
7<sup>7/8</sup> in

200 mm Escurridor 35 mm  
7<sup>7/8</sup> in Dish drying rack 1<sup>17/45</sup> in

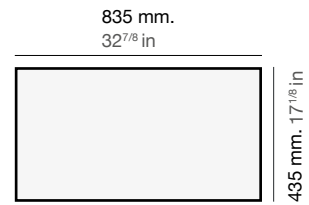
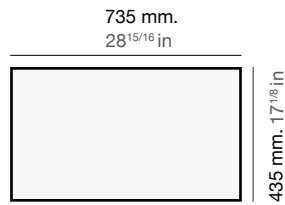
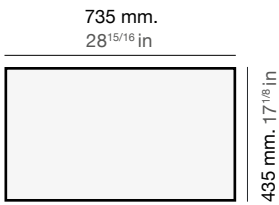

80 cm  
3<sup>3/20</sup> in

80 cm  
3<sup>3/20</sup> in

90 cm  
3<sup>25/46</sup> in

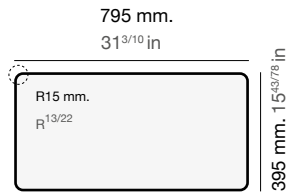
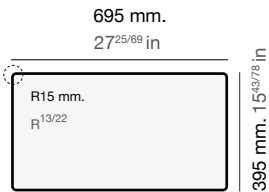
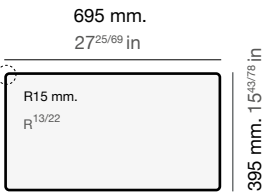

80 cm  
3<sup>3/20</sup> in

80 cm  
3<sup>3/20</sup> in

90 cm  
3<sup>25/46</sup> in

810 x 510 x 300 mm  
16 kg  
33<sup>8/9</sup> x 20<sup>7/89</sup> x 11<sup>73/90</sup> in

810 x 510 x 300 mm  
19 kg  
33<sup>8/9</sup> x 20<sup>7/89</sup> x 11<sup>73/90</sup> in

920 x 510 x 300 mm  
18,3 kg  
36<sup>13/59</sup> x 20<sup>7/89</sup> x 11<sup>73/90</sup> in

400 €

420 €

420 €

Incluye  
Includes  
Inclus

Válvula cuadrada.  
Sifón y sellante.  
Plantillas de encastre.  
Barra de anclaje bajo encimera.

Square valve.  
Siphon and sealant.  
Template inlay.  
Undermount anchor bar.

Vanne carrée.  
Siphon et le colle mastic.  
Le gabarit d'encastrement.  
Barre d'ancrage pour sous plan.

KITCHEN

57



## 03 gandia collection

**Gandia es sencillez y funcionalidad. Su diseño de líneas curvas e integradas con la encimera es la perfecta síntesis entre versatilidad y confort. Un seno pensado para fundirse con cualquier espacio y llenarlo de vida y frescura.**

Gandia, simplicity and functionality. Its design of curved lines integrated with the worktop is the perfect synthesis between versatility and comfort. A sink designed to blend into any space and fill it with vitality and freshness.

Gandia incarne la simplicité et la fonctionnalité. Son design aux lignes courbes et intégrées au plan de travail est la parfaite synthèse entre polyvalence et confort. Une cuve conçue pour se fondre dans n'importe quel espace et le remplir de vie et de fraîcheur.

### **Características** \_Characteristics \_Caractéristiques

Hekla	Antibacteriano	Bajo encimera	Sobre encimera
Hekla	Antibacterial	Undermount	Inset
Hekla	Antibactérien	Sous plan de travail	Sur plan de travail



Ash Gandia 194 Sink  
New York New York Neolith  
Counter  
Walnut finish Magama  
Furniture





# gandia<sub>50</sub>



GANDIA\_50 Ref. 194 Color AS\_Ash

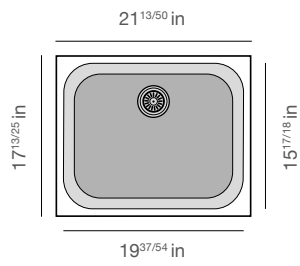
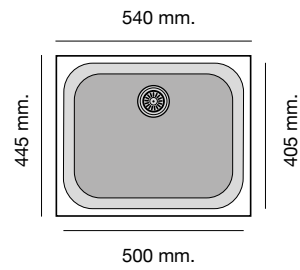

# gandia<sub>40</sub>



GANDIA\_40 Ref. 193 Color BS\_Basalt

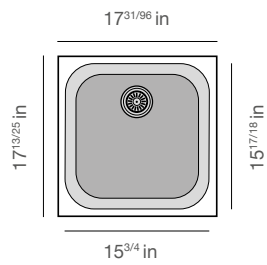
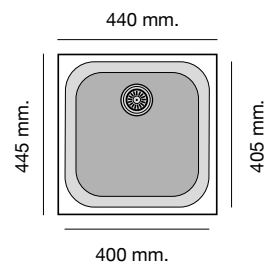





Basalt Gandia 193 Sink  
Nero Neolith Counter  
White finish Magama  
Furniture





# gandia<sub>70</sub>



GANDIA\_70 Ref. 195 Color SW\_Snow

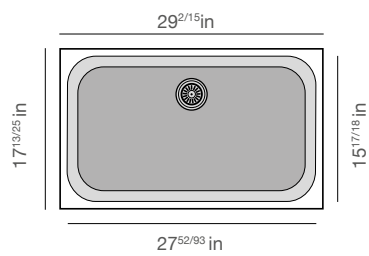
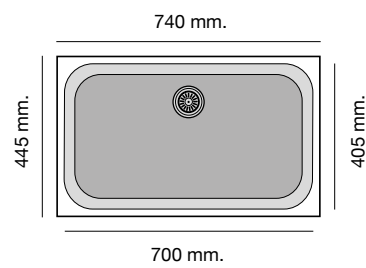

Snow Gandia 195 Sink  
Iron Frost Neolith Counter  
Walnut finish Magama  
Furniture



Pumice Gandia 192 Sink  
Avorio Neolith Counter  
White finish Magama  
Furniture



# gandia<sub>35</sub>



GANDIA\_35 Ref. 192 Color PU\_Pumice

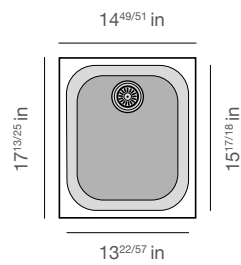
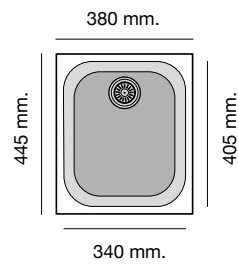

# 03 gandia collection

Modelo Model Modèle	GANDIA_35 Ref. 192	GANDIA_40 Ref. 193	GANDIA_50 Ref. 194	GANDIA_70 Ref. 195
Medidas Measurements Mesures				
Profundidad cubeta Bucket depth Profondeur de la cuve	200 mm 7 <sup>7/8</sup> in	200 mm 7 <sup>7/8</sup> in	200 mm 7 <sup>7/8</sup> in	200 mm 7 <sup>7/8</sup> in
Sobre encimera Inset Sous plan de travail				
Mueble Furniture Meuble	45 cm 1 <sup>71/92</sup> in	50 cm 1 <sup>31/32</sup> in	60 cm 2 <sup>25/69</sup> in	80 cm 3 <sup>3/20</sup> in
Bajo encimera Undermount Sur plan de travail				
Mueble Furniture Meuble	45 cm 1 <sup>71/92</sup> in	50 cm 1 <sup>31/32</sup> in	60 cm 2 <sup>25/69</sup> in	80 cm 3 <sup>3/20</sup> in
Paquete Packaging Colis	540 x 510 x 300 mm 10 kg 21 <sup>13/50</sup> x 20 <sup>7/89</sup> x 11 <sup>73/90</sup> in	540 x 510 x 300 mm 11 kg 21 <sup>13/50</sup> x 20 <sup>7/89</sup> x 11 <sup>73/90</sup> in	680 x 510 x 300 mm 13,5 kg 26 <sup>71/92</sup> x 20 <sup>7/89</sup> x 11 <sup>73/90</sup> in	850 x 510 x 300 mm 17 kg 33 <sup>46/99</sup> x 20 <sup>7/89</sup> x 11 <sup>73/90</sup> in
Tarifa Price Tarif	235 €	245 €	295 €	345 €

Acabados  
Finishes  
Finition





Los precios no incluyen IVA. Esta tarifa anula las anteriores.  
Prices do not include VAT. This price list cancel and substitute the previous ones.  
Les prix ne comprennent pas la TVA. Ce taux annule les précédents.

Incluye  
Includes  
Inclus

Válvula circular.  
Sifón y sellante.  
Plantillas de encastre.  
Barra de anclaje bajo encimera.

Circular valve.  
Siphon and sealant.  
Template inlay.  
Undermount anchor bar

Vanne circulaire.  
Siphon et le colle mastic.  
Le gabarit d'encastrement.  
Barre d'ancrage pour sous plan

KITCHEN

73



Pumice City 331 Sink  
Petra White River Compac  
Counter  
White finish Magama  
Furniture

## 04 city collection

No renuncies al mejor diseño con los precios más competitivos. City es la más camaleónica de las colecciones de Poalgi. Sus líneas curvas añaden una elegante simplicidad a cada composición. Con infinidad de acabados, que aportan a nuestra colección un estilo adaptable a todo tipo de cocinas y estilos, siempre bajo la premisa de aportar calidad con el mejor coste.

Why not try one of the best designs with the most competitive prices City is the most chameleonic of Poalgi's collections. Its curved lines add an elegant simplicity to each composition. Poalgi offers you infinite finishes, which give our collection the adaptability to suite all types of kitchens and styles, always under the premise of providing quality at the best cost.

Simplicité et fonctionnalité. City constitue la gamme de produit la plus large des éviers Poalgi offrant une réponse à toute configuration et implantation de cuisine. Ses lignes courbes ajoutent une élégante simplicité à chaque composition. Poalgi propose de nombreuses finitions apportant adaptabilité et polyvalence quel que soit le style choisi. Un produit simple... et toujours de grande qualité.

### Características \_Characteristics \_Caractéristiques

Hekla	Antibacteriano	Textura lisa	Sobre encimera
Hekla	Antibacterial	Silk texture	Inset
Hekla	Antibactérien	Texture silk	Sur plan de travail

# city<sub>331</sub>

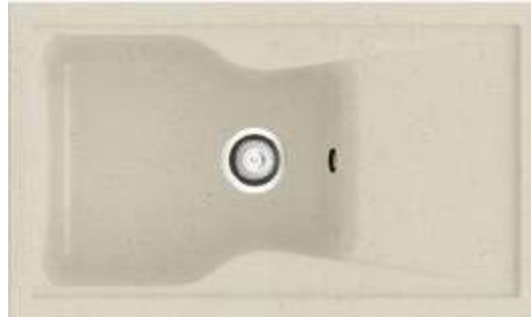

CITY Ref. 331 Color\_PU\_Pumice

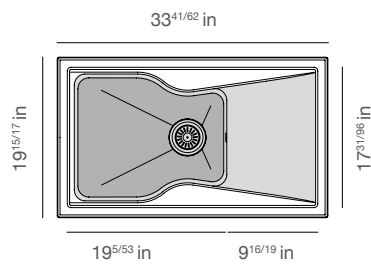
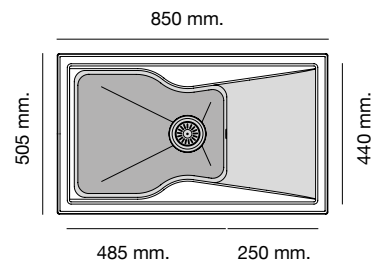









Ash City 330 Sink  
Cobweb Compac Counter  
White finish Magama  
Furniture



# city<sub>330</sub>



CITY Ref. 330 Color\_AS\_Ash

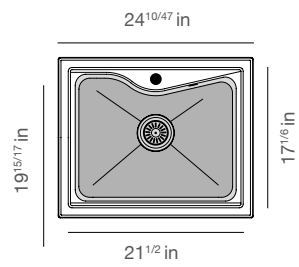
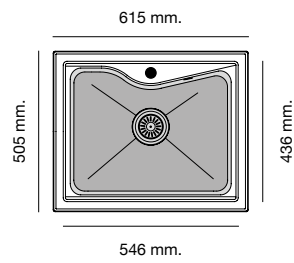

# city<sub>332</sub>

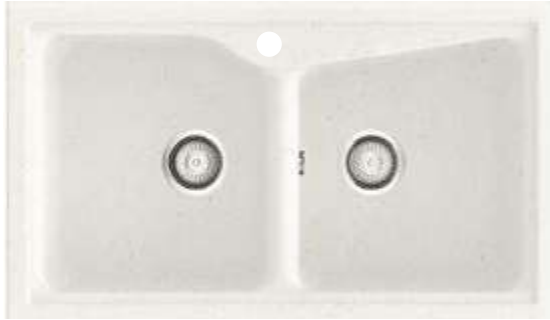

CITY Ref. 332 Color\_SW\_Snow

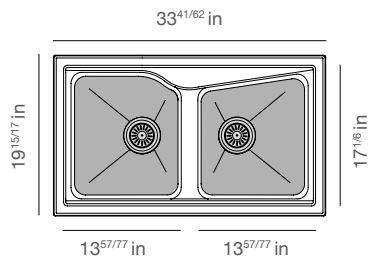
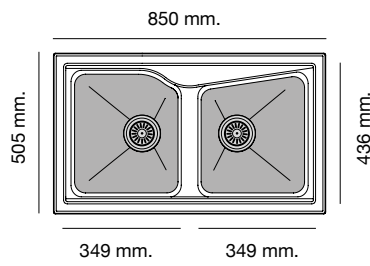

Snow City 332 Sink





Basalt City 333 Sink  
Walnut finish Magama  
Furniture

# city<sub>333</sub>

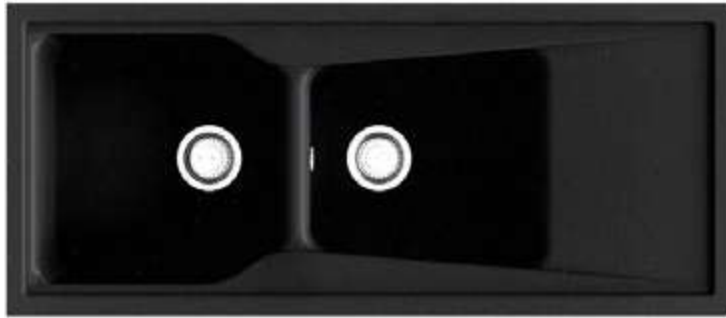

CITY Ref. 333 Color\_BS\_Basalt

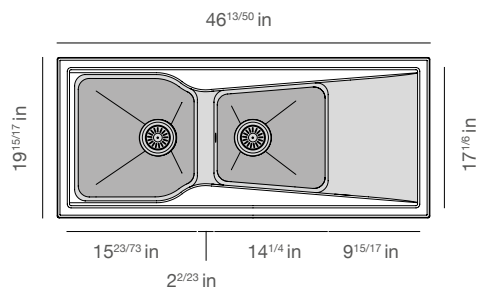
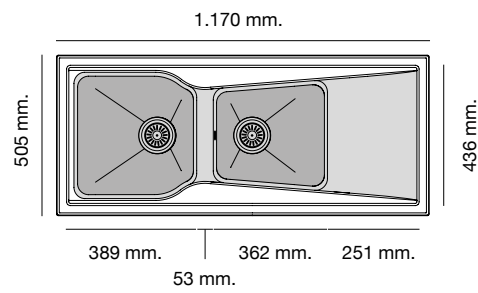

# 04 city collection

Modelo  
Model  
Modèle

CITY Ref. 330

CITY Ref. 331

CITY Ref. 332

Medidas  
Measurements  
Mesures

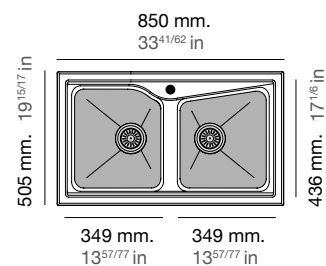
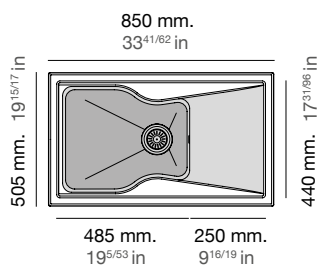
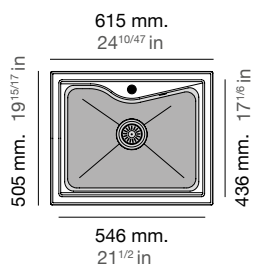

Profundidad cubeta  
Bucket depth  
Profondeur de la cuve

220 mm  
8<sup>43/65</sup> in

220 mm  
8<sup>43/65</sup> in

220 mm  
8<sup>43/65</sup> in

Sobre encimera  
Inset  
Sous plan de travail

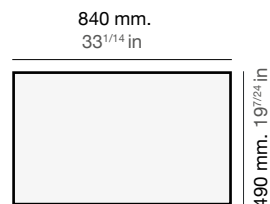
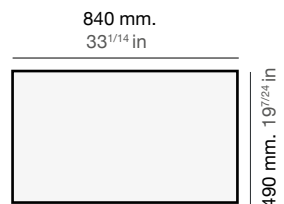
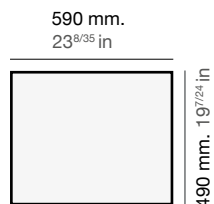

Mueble  
Furniture  
Meuble

60 cm  
2<sup>25/69</sup> in

70 cm  
2<sup>65/86</sup> in

90 cm  
3<sup>25/46</sup> in

Paquete  
Packaging  
Colis

680 x 570 x 270 mm  
12,5 kg  
26<sup>71/92</sup> x 22<sup>15/34</sup> x 10<sup>17/27</sup> in

920 x 570 x 270 mm  
17 kg  
36<sup>13/59</sup> x 22<sup>15/34</sup> x 10<sup>17/27</sup> in

920 x 570 x 270 mm  
18 kg  
36<sup>13/59</sup> x 22<sup>15/34</sup> x 10<sup>17/27</sup> in

Tarifa  
Price  
Tarif

260 €

295 €

365 €

Acabados  
Finishes  
Finition

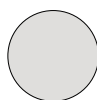

SNOW



PUMICE



ASH



BASALT

Los precios no incluyen IVA. Esta tarifa anula las anteriores.  
Prices do not include VAT. This price list cancel and substitute the previous ones.  
Les prix ne comprennent pas la TVA. Ce taux annule les précédents.

CITY Ref. 333

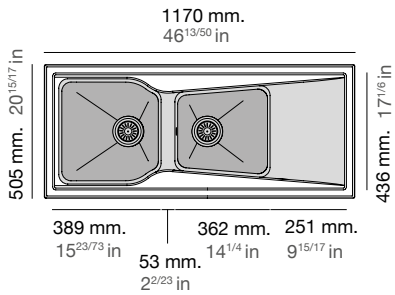

200 mm  
7<sup>7/8</sup> in

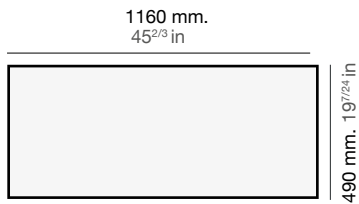

90 cm  
3<sup>25/46</sup> in

1.200 x 570 x 270 mm  
23 kg  
47<sup>21/86</sup> x 22<sup>15/34</sup> x 10<sup>17/27</sup> in

410 €

Incluye  
Includes  
Inclus

Válvula circular.  
Sifón y sellante.  
Garras de anclaje  
Plantillas de encastre.

Circular valve.  
Siphon and sealant.  
Anchor claws  
Template inlay.

Vanne circulaire.  
Siphon et le colle mastic.  
Griffes d'ancrage  
Le gabarit d'encastrement.

# Roc Stone<sup>®</sup>

poolgi

Fregaderos sintéticos  
Resin kitchen sinks  
Eviens synthétiques



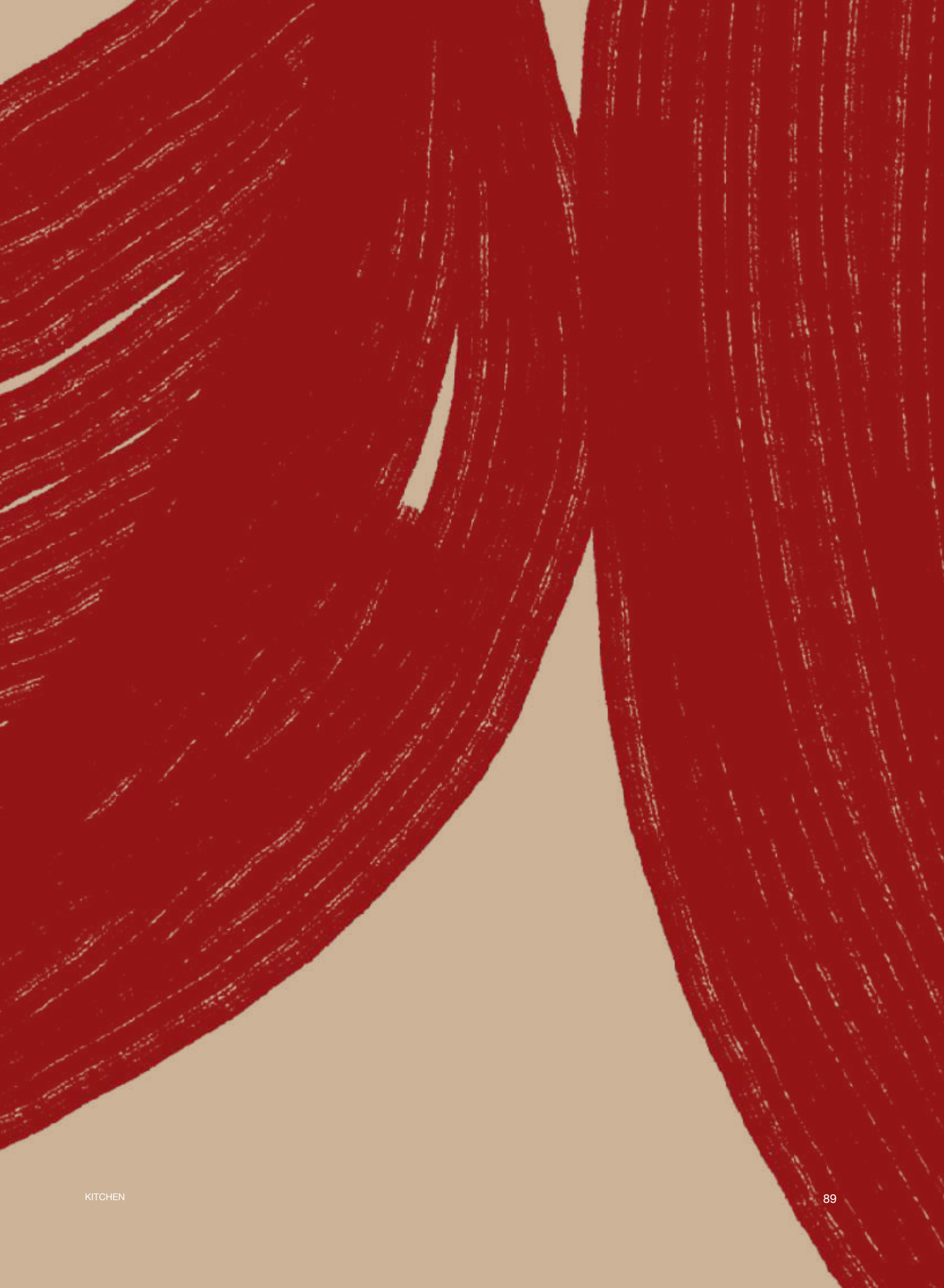







RocStone® es un material compuesto de cargas minerales aglutinadas con resinas técnicas de alta resistencia. Esta mezcla surge de un proceso de investigación certificado por AENOR. El componente principal del RocStone® es la partícula de alúmina. Empleamos tres granulometrías diferentes de alúmina para conseguir una masa compacta y homogénea. La resina técnica añadida envuelve cada partícula de alúmina formando un material altamente compactado. La superficie de nuestros fregaderos está formulada por un Gel\_Coat de altas resistencia y prestaciones. El tratamiento en superficie de nuestros productos no deja lugar a la aparición de posibles bacterias.

RocStone® garantiza la resistencia bajo carga, el daño de impacto y los efectos de las altas y bajas temperaturas, además de la seguridad del transporte, la instalación y el uso diario. Gracias al tratamiento V (de anti-vejecimiento), la superficie del fregadero se mantiene en perfectas condiciones durante toda su vida útil.

RocStone® is a material composed of mineral fillers bonded with high-strength technical resins. This mixture arises from a research process certified by AENOR. The main component of RocStone is the 'alumina particle'. We use different granulometries of alumina to achieve a more compact and homogeneous mass. The added technical resin surrounds each alumina particle to form a highly compacted material. The surface of our Sinks is formulated with a Gel\_Coat of equal high resistance and performance. The surface treatment of our products leaves no room for bacterial growth.

RocStone® guarantees resistance under load, impact bathing and the effects of high and low temperatures, as well as safety during transportation, installation and daily use. Also, with the V (anti-ageing) treatment, the surface of the sink remains in perfect condition throughout its lifetime.

RocStone® est un composite à base de charges minérales liées à des résines à haute résistance. Ce mélange émerge d'un processus de recherche certifié par AENOR. Le composant principal du RocStone® est la particule d'alumine. Nous utilisons trois granulométries différentes d'alumine pour obtenir une masse compacte et homogène. La résine technique ajoutée entoure chaque particule d'alumine formant un matériau fortement compacté. La surface de nos éviers est composée d'un Gel\_Coat de haute résistance et performance.

RocStone® garantit la résistance à la charge, les dommages d'un impact et les effets des hautes et basses températures, ainsi que la sécurité pendant le transport, l'installation et l'utilisation quotidienne. Grâce à un traitement anti-âge, chez Poalgi, nous obtenons que nos produits conservent leur apparence et état pendant des années.





# Colorplus

poalgi





# Imagina un color hazlo Poalgi

Imagine any colour, make it Poalgi

Imagine une couleur, Poalgi se charge de la concevoir

CITY Ref. 321 Colorplus\_RAL 6012\_Finish\_Gloss



# Colorplus

poalgi

RAL 6012  
PANTONE 7546  
NCS S8010-B50G  
RGB 53,71,67  
CMYK 74, 49, 57,53  
#354743



Con ColorPlus, Poalgi consigue adaptar el color de tu fregadero a partir del color de cualquier superficie (encimeras sintéticas, encimeras de madera, piedra sintetizada, cerámica, porcelánicos, compactos) y/o gama de color tipo carta universal RAL o NCS.

With ColorPlus, Poalgi manages to adapt the colour of your sink from the colour of any surface (synthetic countertops, wooden countertops, synthesised stone, ceramic, porcelain, compact surfaces) and/or colour range such as the universal RAL or NCS colour charts.

Avec ColorPlus, Poalgi réussit à adapter la couleur de votre évier à partir de la couleur de tout plan de travail (synthétiques, bois, céramiques, compactes) et/ou la gamme de couleur de type carte universel RAL ou NCS.

— Los colores tienen el poder de evocar sensaciones, y también recuerdos. No elijas un color: imagínalo, invéntalo, recuérdalo. Hazlo Poalgi. —

— The colours have the power to evoke sensations as well as memories. Do not choose a colour, imagine it, invent it, remember it. Make it Poalgi. —

— Les couleurs ont le pouvoir de nous provoquer des sensations, mais également des souvenirs. Ne choisissez pas une couleur : imaginez-la, inventez-la, rappelez-la. Poalgi se charge de la concevoir. —

NEOLITH

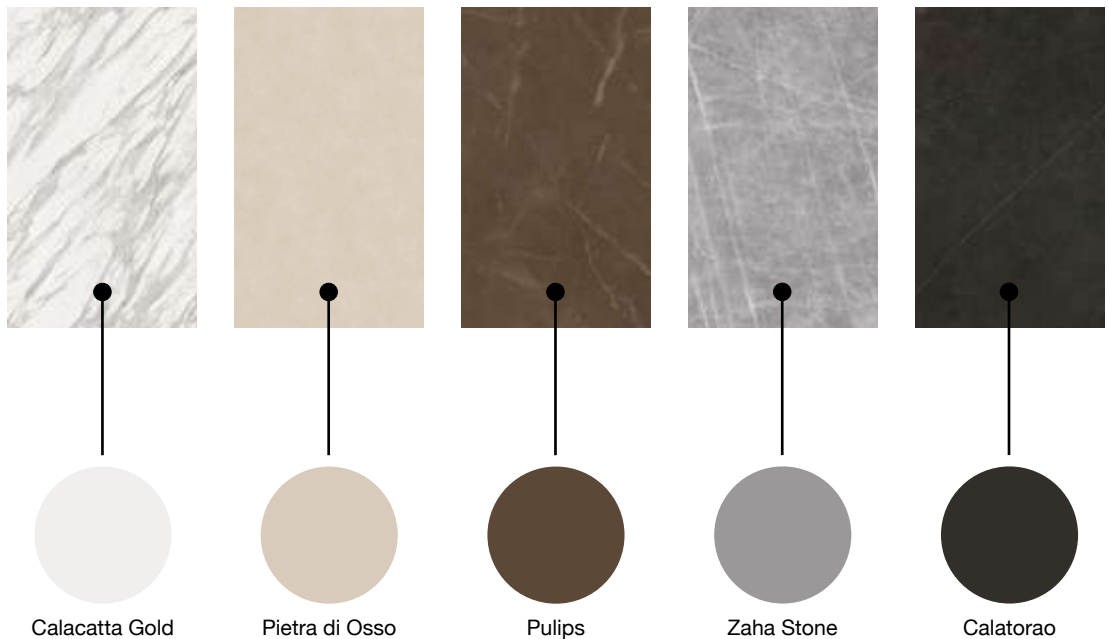

Colorplus System

Calacatta Gold

Pietra di Osso

Pulips

Zaha Stone

Calatorao

Las nuevas tendencias en el diseño de cocinas y sus altas posibilidades de personalización hacen necesario una respuesta estética para poder combinar los múltiples acabados y materiales. Esta respuesta Poalgi la da a través del sistema ColorPlus.

The new trends in kitchen design and their high customisation possibilities make it necessary to find an aesthetic answer to combine the multiple finishes and materials. Poalgi gives this answer through ColorPlus.

Les nouvelles tendances dans la conception des cuisines et ses grandes possibilités de personnalisation rendent nécessaire une réponse esthétique pour pouvoir combiner les multiples finitions et matériaux. Cette réponse, Poalgi la donne à travers son système ColorPlus.

# 01 zie collection

La colección Zie ha sido creada para cumplir con un gran desafío: un nuevo concepto de cocina, adaptada al siglo XXI. Los diseños minimalistas, de líneas cuadradas, depuradas y aparente simplicidad convierten a Zie en una colección que busca sofisticación y modernidad. La versatilidad de nuestros modelos pone en su mano una infinidad de acabados y composiciones.





Poalgi has created the Zie collection to meet great challenges and new kitchen concepts, adapted to the 21st century. Minimalist designs, square, clean lines and apparent simplicity make Zie a collection that seeks sophistication and modernity. The versatility of our models offers an infinite number of finishes and compositions.

Poalgi a conçu la collection Zie dans l'idée de relever un défi: imaginer un nouveau concept de cuisine, adapté au XXIème siècle. Un dessin minimaliste, des arêtes marquées, une ligne épurée et d'apparente simplicité : la collection Zie se caractérise par sa sophistication et sa modernité. La polyvalence de nos modèles rendent possible une multitude de finitions et de compositions.

#### **Características** \_Characteristics \_Caractéristiques

Roc Stone	Antibacteriano	Bajo encimera	Sobre encimera
Roc Stone	Antibacterial	Undermount	Inset
Roc Stone	Antibactérien	Sous plan de travail	Sur plan de travail





zie<sub>81</sub>

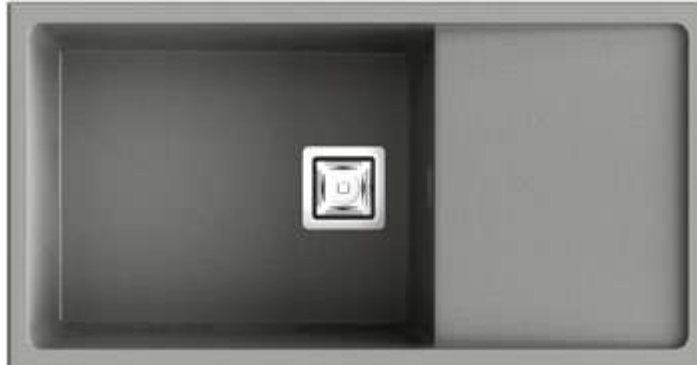

ZIE\_81 1C + Esc. Ref. 185. Color **standard**\_CT Concret  
Finish\_Soft

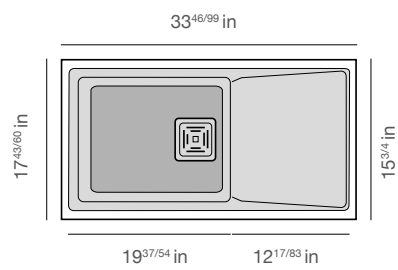
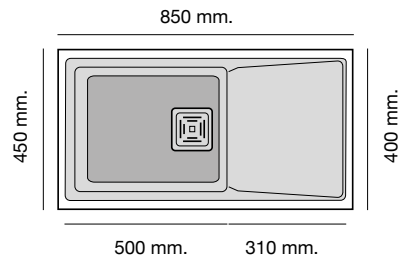



zie<sub>50</sub>



ZIE\_50 Ref. 176 Colorstandard TU\_Tundra  
Finish\_Gloss

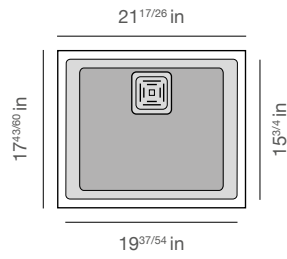
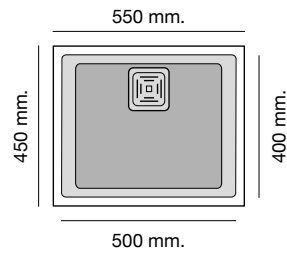



zie<sub>60</sub>



ZIE\_60 + Esc. Ref. 182. Color **standard**\_NL Negro Liso  
Finish\_Soft

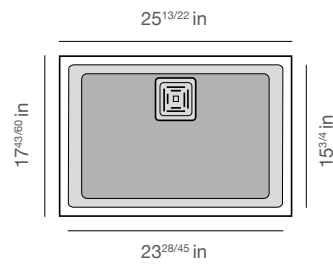
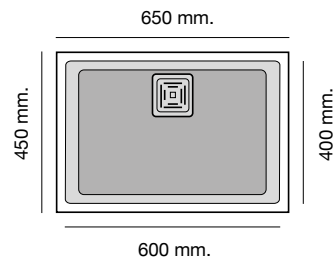





COMPAC  
THE SURFACES COMPANY  
Darkconcrete

P NL\_Negro Liso





# zie<sub>70 1 1/2 C</sub>

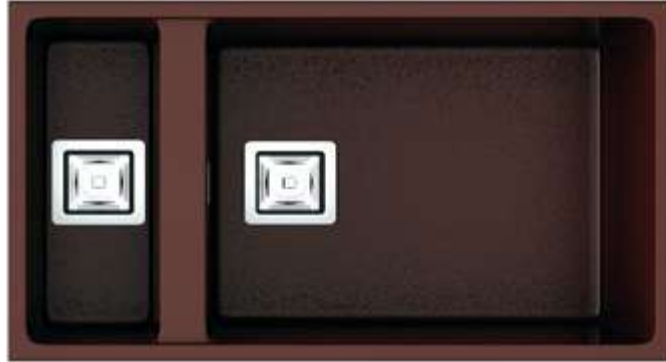

ZIE\_70\_1<sup>1/2</sup> C Ref. 173. Colorplus\_Ral\_8015  
Finish\_Gloss

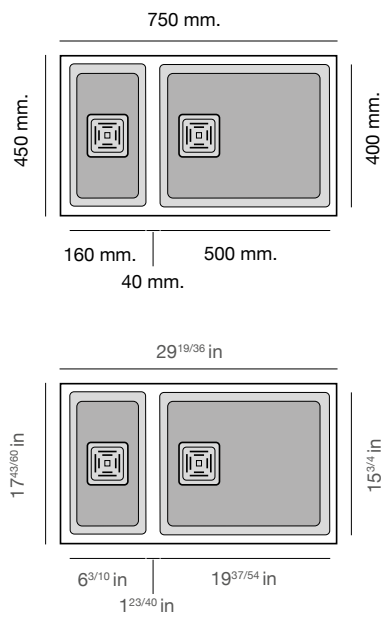



zie<sub>70</sub>



ZIE\_70 Ref. 187 Colorstandard PG\_Pergamon  
Finish\_Soft

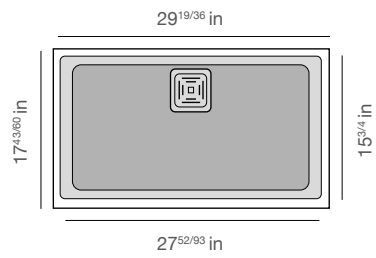
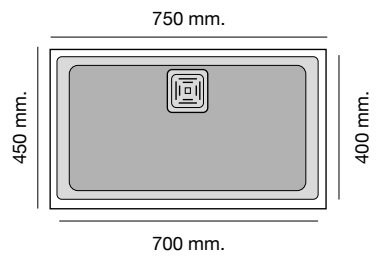



# zie<sub>70 2C</sub>



ZIE\_70\_2C Ref. 174. Color **standard**\_BL\_Blanco.  
Finish\_Gloss

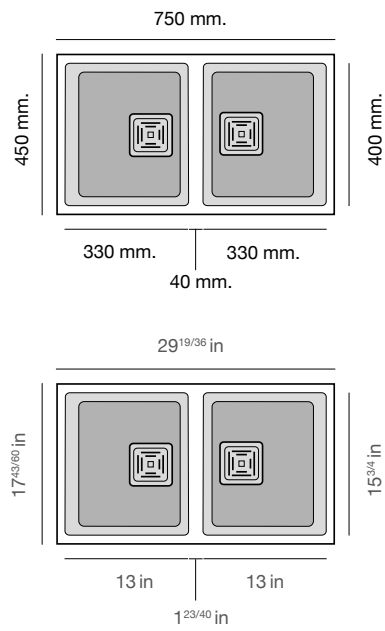



# 01 zie collection

<b>Modelo</b>	ZIE_45 Ref. 171_ Gloss	ZIE_50 Ref. 176_ Gloss	ZIE_60 Ref. 172_ Gloss	ZIE_70 1C. Ref. 177_ Gloss
<b>Model</b>	ZIE_45 Ref. 181_ Soft	ZIE_50 Ref. 186_ Soft	ZIE_60 Ref. 182_ Soft	ZIE_70 1C. Ref. 187_ Soft
<b>Modèle</b>				

<b>Medidas</b> Measurements Mesures	500 mm. 19 <sup>37/54</sup> in	550 mm. 21 <sup>17/26</sup> in	650 mm. 25 <sup>13/22</sup> in	750 mm. 29 <sup>19/36</sup> in

<b>Profundidad cubeta</b>	200 mm	200 mm	200 mm	200 mm
<b>Bucket depth</b>	7 <sup>7/8</sup> in	7 <sup>7/8</sup> in	7 <sup>7/8</sup> in	7 <sup>7/8</sup> in
<b>Profondeur de la cuve</b>				

<b>Sobre encimera</b> Inset Sous plan de travail	485 mm. 19 <sup>5/53</sup> in	535 mm. 21 <sup>1/16</sup> in	635 mm. 25 in	735 mm. 28 <sup>15/16</sup> in

<b>Mueble</b>	50 cm	60 cm	70 cm	80 cm
<b>Furniture</b>	1 <sup>31/32</sup> in	2 <sup>25/69</sup> in	2 <sup>65/86</sup> in	3 <sup>3/20</sup> in
<b>Meuble</b>				

<b>Bajo encimera</b> Undermount Sur plan de travail	445 mm. 17 <sup>13/25</sup> in	495 mm. 19 <sup>21/43</sup> in	595 mm. 23 <sup>37/87</sup> in	695 mm. 27 <sup>25/69</sup> in

<b>Mueble</b>	60 cm	60 cm	70 cm	80 cm
<b>Furniture</b>	2 <sup>25/69</sup> in	2 <sup>25/69</sup> in	2 <sup>65/86</sup> in	3 <sup>3/20</sup> in
<b>Meuble</b>				

<b>Paquete</b>	570 x 520 x 280 mm	610 x 500 x 240 mm	720 x 520 x 280 mm	850 x 500 x 240 mm
<b>Packaging</b>	9,8 kg	13 kg	11,35 kg	15,75 kg
<b>Colis</b>	22 <sup>15/34</sup> x 20 <sup>43/91</sup> x 11 <sup>2/85</sup> in	24 <sup>1/64</sup> x 19 <sup>37/54</sup> x 9 <sup>22/49</sup> in	28 <sup>9/26</sup> x 20 <sup>43/91</sup> x 11 <sup>2/85</sup> in	33 <sup>46/99</sup> x 19 <sup>37/54</sup> x 9 <sup>22/49</sup> in

<b>Tarifa</b> Price Tarif		standard	plus	standard	plus	standard	plus	standard	plus
	Gloss	275 €	330 €	285 €	345 €	305 €	370 €	315 €	385 €
	Soft	315 €	385 €	325 €	395 €	345 €	420 €	365 €	440 €

**Acabados**  
Finishes  
Finition



Los precios no incluyen IVA. Esta tarifa anula las anteriores.  
 Prices do not include VAT. This price list cancel and substitute the previous ones.  
 Les prix ne comprennent pas la TVA. Ce taux annule les précédents.

ZIE\_70 11/2C. Ref. 173\_ Gloss  
 ZIE\_70 11/2C. Ref. 183\_ Soft

ZIE\_70 2C. Ref. 174\_ Gloss  
 ZIE\_70 2C. Ref. 184\_ Soft

ZIE\_81 Ref. 175\_ Gloss  
 ZIE\_81 Ref. 185\_ Soft

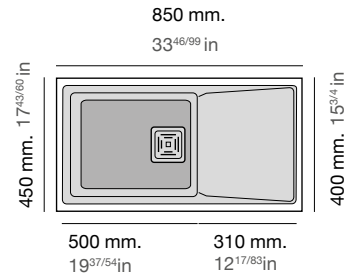
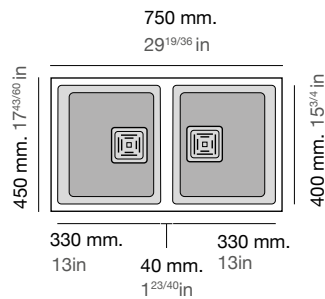
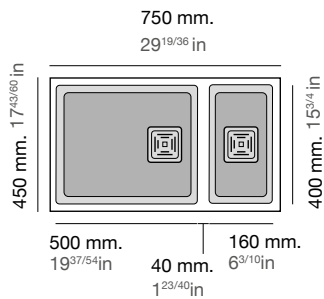

200 mm + 150 mm  
 7<sup>7/8</sup> + 5<sup>48/53</sup> in

200 mm  
 7<sup>7/8</sup> in

200 mm Escurreidor 35 mm  
 7<sup>7/8</sup> in Dish drying rack 1<sup>17/45</sup> in

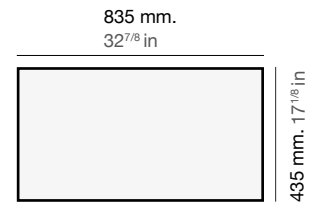
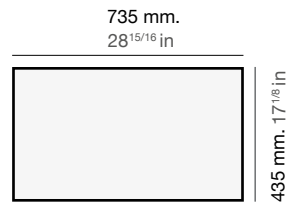
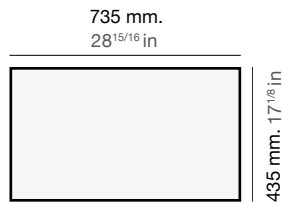

80 cm  
 3<sup>3/20</sup> in

80 cm  
 3<sup>3/20</sup> in

90 cm  
 3<sup>25/46</sup> in

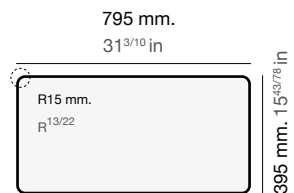
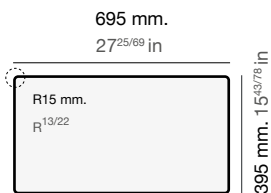
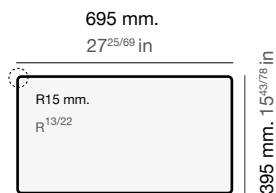

80 cm  
 3<sup>3/20</sup> in

80 cm  
 3<sup>3/20</sup> in

90 cm  
 3<sup>25/46</sup> in

810 x 520 x 280 mm  
 11 kg  
 31<sup>8/9</sup> x 20<sup>43/91</sup> x 11<sup>2/85</sup> in

810 x 520 x 280 mm  
 16,10 kg  
 31<sup>8/9</sup> x 20<sup>43/91</sup> x 11<sup>2/85</sup> in

930 x 520 x 280 mm  
 15,3 kg  
 36<sup>43/70</sup> x 20<sup>43/91</sup> x 11<sup>2/85</sup> in

standard	plus
350 €	430 €
400 €	490 €

standard	plus
375 €	460 €
425 €	520 €

standard	plus
375 €	460 €
425 €	520 €

Incluye Válvula cuadrada.  
 Includes Sifón y sellante.  
 Inclus Plantillas de encastre.  
 Barra de anclaje bajo encimera.

Square valve.  
 Siphon and sealant.  
 Template inlay.  
 Undermount anchor bar included.

Vanne carrée.  
 Siphon et le colle mastic.  
 Le gabarit d'encastrement.  
 Barre d'ancrage pour sous plan inclus.

02 gandia  
collection

La nueva estética de la cocina. Es la síntesis de los espacios diseñados con líneas integradas, limpias y funcionales. La colección Gandia es la primera de nuestras series por su gran capacidad para aportar a la cocina los diseños más atrevidos. Sus modelos han logrado convertir las encimeras en superficies lisas de líneas puras dotando un gran orden de continuidad creando tendencia.



The new kitchen aesthetic. It is the synthesis of spaces designed with integrated, clean and functional lines. The Gandia collection is the first of our series due to its great capacity to bring the most daring designs into the kitchen. Its models have managed to convert the smooth surface worktops and pure lines providing a great order of trend- creating continuity.

Esthétisme et fonctionnalité. La collection Gandia est la meilleure alliée des espaces conçus avec des lignes intégrées, simples et fonctionnelles. Par ses multiples combinaisons possibles, elle constitue un atout important pour les conceptions de cuisine, même les plus audacieuses. Grâce à cette collection, valorisez également votre plan de travail, en gardant continuité et pureté des lignes.

**Características** \_Characteristics \_Caractéristiques

Roc Stone	Antibacteriano	Bajo encimera	Sobre encimera
Roc Stone	Antibacterial	Under mount	Inset
Roc Stone	Antibactérien	Sous plan de travail	Sur plan de travail





# gandia<sub>50</sub>



GANDIA\_50 Ref. 164. Color **standard**\_AL\_Albero.  
Finish\_ Gloss

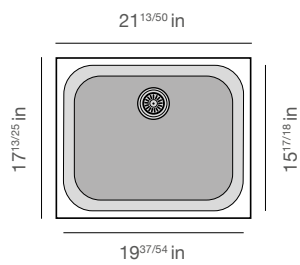
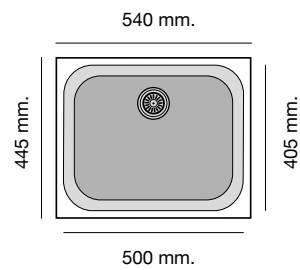





# gandia<sub>70</sub>



GANDIA\_70 Ref. 195. Color **standard\_NL\_Negro Liso**  
Finish\_ Soft

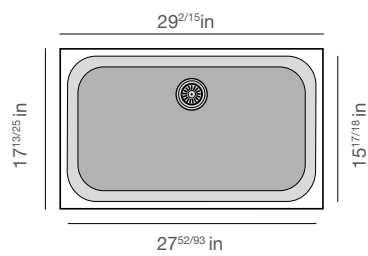
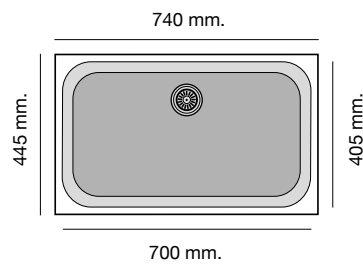





# gandia<sub>15</sub>



GANDIA\_15 Ref. 161 + GANDIA\_50 Ref. 164  
Color **standard**\_PG\_Pergamon Finish\_ Gloss

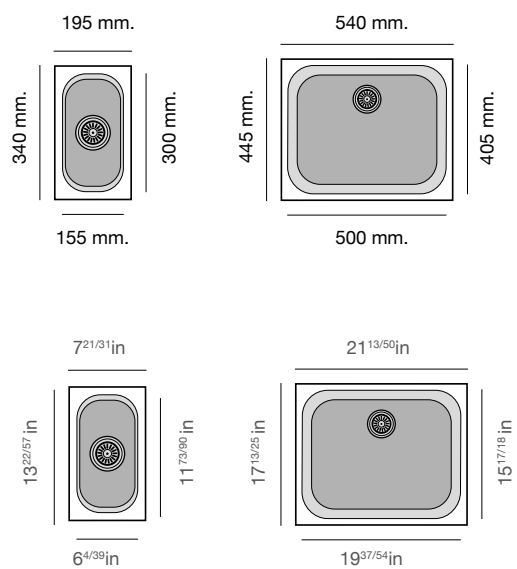

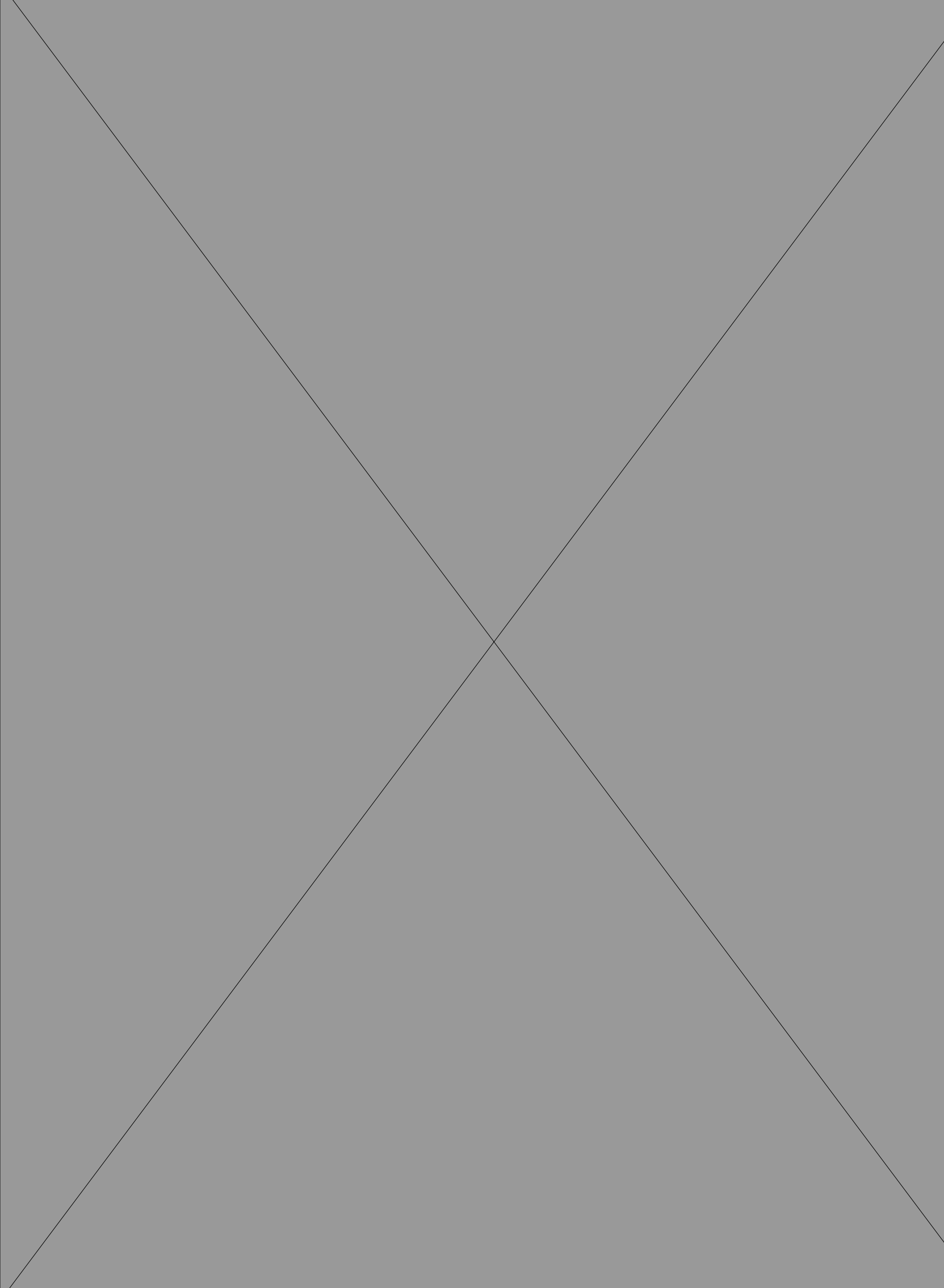







# 02 gandia collection

<b>Modelo</b>	GANDIA_ 15 Ref. 161_ Gloss	GANDIA_ 35 Ref. 162_ Gloss	GANDIA_ 40 Ref. 163_ Gloss
<b>Model</b>		GANDIA_ 35 Ref. 192_ Soft	GANDIA_ 40 Ref. 193_ Soft
<b>Modèle</b>			

**Medidas**  
Measurements  
Mesures

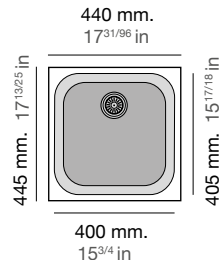
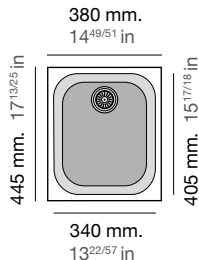
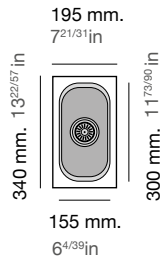

**Profundidad cubeta**  
Bucket depth  
Profondeur de la cuve

200 mm  
7 7/8 in

200 mm  
7 7/8 in

200 mm  
7 7/8 in

**Sobre encimera**  
Inset  
Sous plan de travail

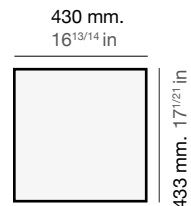
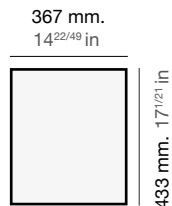
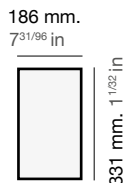

**Mueble**  
Furniture  
Meuble

-

45 cm  
1 71/92 in

50 cm  
1 31/32 in

**Bajo encimera**  
Undermount  
Sur plan de travail

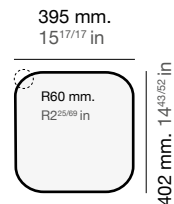
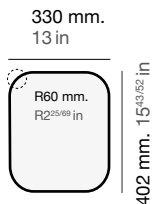
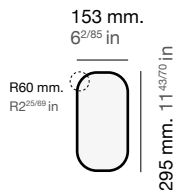

**Mueble**  
Furniture  
Meuble

-

45 cm  
1 71/92 in

50 cm  
1 31/32 in

**Paquete**  
Packaging  
Colis

510 x 510 x 280 mm  
3,90 kg

510 x 510 x 280 mm  
9,2 kg

510 x 510 x 280 mm  
10,6 kg

20 7/89 x 20 7/89 x 11 2/85 in

21 13/50 x 20 7/89 x 11 2/85 in

21 13/50 x 20 7/89 x 11 2/85 in

**Tarifa**  
Price  
Tarif

	standard	plus
Gloss	105 €	125 €
Soft	-	-

	standard	plus
Gloss	200 €	240 €
Soft	235 €	280 €

	standard	plus
Gloss	210 €	255 €
Soft	245 €	295 €

**Acabados**  
Finishes  
Finition



Los precios no incluyen IVA. Esta tarifa anula las anteriores.  
 Prices do not include VAT. This price list cancel and substitute the previous ones.  
 Les prix ne comprennent pas la TVA. Ce taux annule les précédents.

GANDIA\_ 50 Ref. 164\_ Gloss  
 GANDIA\_ 50 Ref. 194\_ Soft

GANDIA\_ 70 Ref. 165\_ Gloss  
 GANDIA\_ 70 Ref. 195\_ Soft

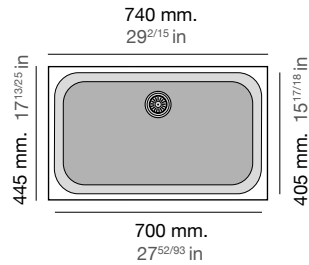
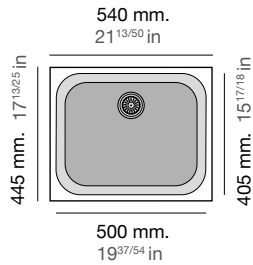

200 mm  
 7<sup>7/8</sup> in

200 mm  
 7<sup>7/8</sup> in

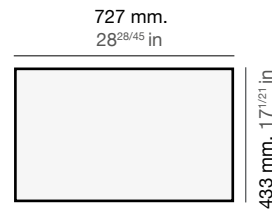
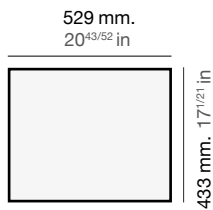

60 cm  
 2<sup>25/69</sup> in

80 cm  
 3<sup>3/20</sup> in

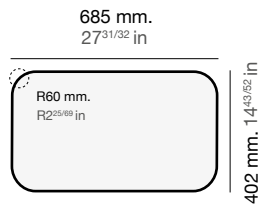
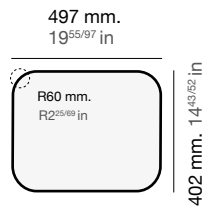

60 cm  
 2<sup>25/69</sup> in

80 cm  
 3<sup>3/20</sup> in

610 x 510 x 280 mm  
 11,5 kg  
 24<sup>1/64</sup> x 20<sup>7/89</sup> x 11<sup>2/85</sup> in

810 x 510 x 280 mm  
 15,4 kg  
 31<sup>8/9</sup> x 20<sup>7/89</sup> x 11<sup>2/85</sup> in

standard	plus
255 €	310 €
295 €	355 €

standard	plus
295 €	365 €
345 €	415 €

Incluye  
 Includes  
 Inclus

Válvula circular.  
 Sifón y sellante.  
 Plantillas de encastre.  
 Barra de anclaje bajo encimera.

Circular valve.  
 Siphon and sealant.  
 Template inlay.  
 Undermount anchor bar.

Vanne circulaire.  
 Siphon et le colle mastic.  
 Le gabarit d'encastrement.  
 Barre d'ancrage pour sous plan.

03 shira  
collection

La cocina tiene vida, Poalgi te ayuda a disfrutarla. La colección Shira logra una estética rompedora y una vitalidad cromática que traslada la cocina a una nueva dimensión. Los materiales sofisticados y armónicos convierten a la colección Shira en sinónimo de funcionalidad, frescura, espacios vivos y desenfadados.



The kitchen exudes life, Poalgi helps you enjoy it. This collection achieves a groundbreaking aesthetic and a chromatic vitality that takes the kitchen to a new dimension. Sophisticated and harmonious materials make the Shira collection synonymous with functionality, freshness, and lively, carefree living spaces.

La cuisine est un lieu de vie et de partage; Poalgi vous aide à en profiter pleinement. Le dessin affirmé de la collection Shira, associé à une couleur originale, projetera votre cuisine dans une nouvelle dimension esthétique. Les matériaux sophistiqués et harmonieux de cette collection font des éviers Shira un hymne à la fonctionnalité et à la fraîcheur stylistique.

**Características** \_Characteristics \_Caractéristiques

Roc Stone	Antibacteriano	Bajo encimera	Sobre encimera
Roc Stone	Antibacterial	Under mount	Inset
Roc Stone	Antibactérien	Sous plan de travail	Sur plan de travail



# shira<sub>505</sub>



SHIRA Ref. 505 Colorstandard\_TU\_Tundra

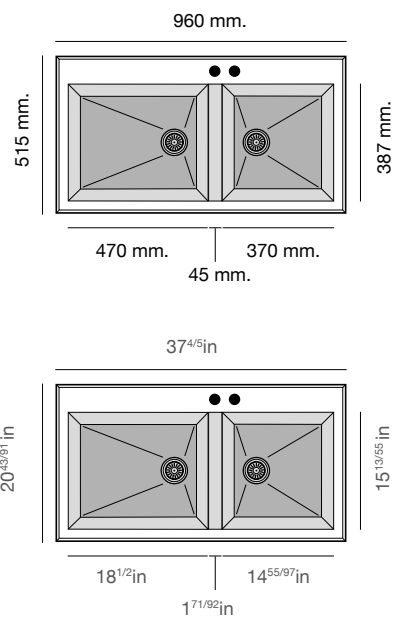



COMPAC  
THE SURFACES COMPANY  
Unique Calacatta

p TU\_Tundra





# shira<sub>503</sub>



SHIRA Ref. 503D Colorstandard\_BR\_Brown.

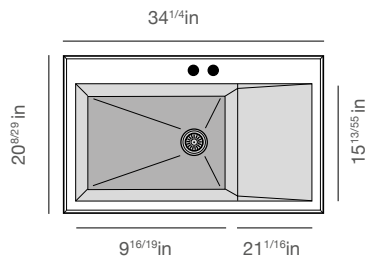
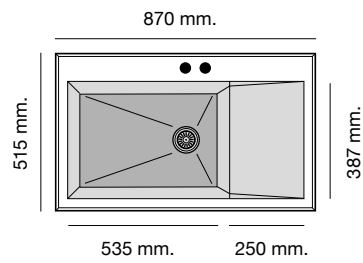





# shira<sub>501</sub>



SHIRA Ref. 501 Colorstandard\_AL\_Albero

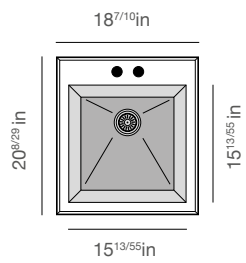
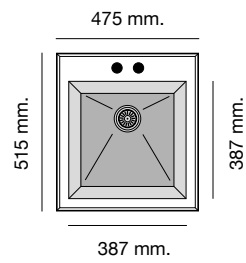





# shira<sub>502</sub>



SHIRA Ref. 502 Colorplus\_Ral\_7043

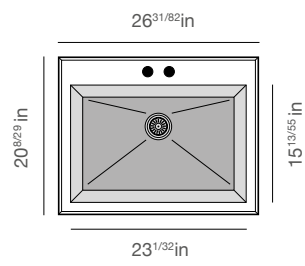
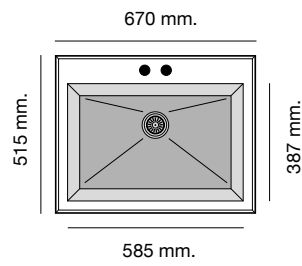



# shira<sub>504</sub>



SHIRA Ref. 504 Colorstandard\_BL\_Blanco

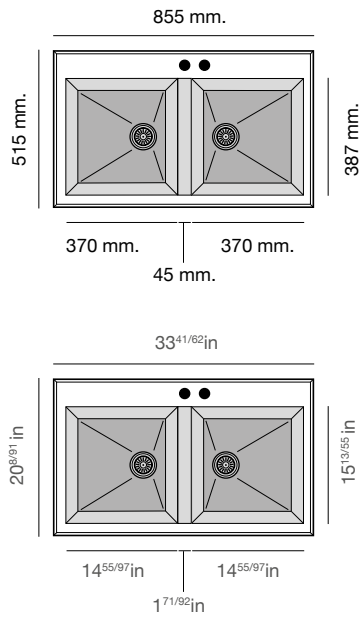





# shira<sub>507</sub>



SHIRA Ref. 507D Colorstandard\_NL\_Negro Liso

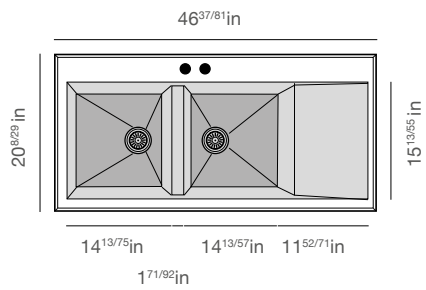
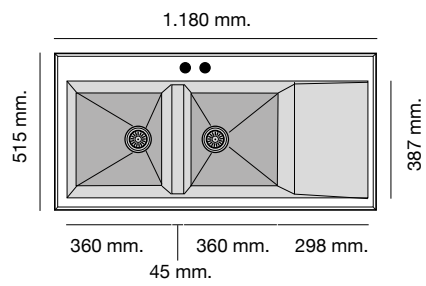

# 03 shira collection

Modelo Model Modèle	SHIRA Ref. 501	SHIRA Ref. 502	SHIRA Ref. 503 D SHIRA Ref. 503 I	SHIRA Ref. 504
Medidas Measurements Mesures				
Profundidad cubeta Bucket depth Profondeur de la cuve	220 mm 8 <sup>43/65</sup> in	220 mm 8 <sup>43/65</sup> in	220 mm 8 <sup>43/65</sup> in	220 mm 8 <sup>43/65</sup> in
Sobre encimera Inset Sous plan de travail				
Mueble Furniture Meuble	45 cm 1 <sup>71/92</sup> in	70 cm 2 <sup>65/86</sup> in	60 cm 2 <sup>25/69</sup> in	90 cm 3 <sup>25/46</sup> in
Bajo encimera Undermount Sur plan de travail				
Mueble Furniture Meuble	50 cm 1 <sup>31/32</sup> in	70 cm 2 <sup>65/86</sup> in	90 cm 3 <sup>25/46</sup> in	90 cm 3 <sup>25/46</sup> in
Paquete Packaging Colis	540 x 580 x 290 mm 11,3 kg 21 <sup>13/50</sup> x 22 <sup>5/16</sup> x 11 <sup>5/12</sup> in	740 x 580 x 290 mm 14,7 kg 29 <sup>2/15</sup> x 22 <sup>5/4</sup> x 11 <sup>5/12</sup> in	940 x 580 x 310 mm 18,4 kg 37 x 22 <sup>5/16</sup> x 12 <sup>17/83</sup> in	920 x 580 x 310 mm 20,51 kg 36 <sup>13/59</sup> x 22 <sup>5/16</sup> x 12 <sup>17/83</sup> in
Tarifa Price Tarif	standard plus Gloss 270 € 330 €	standard plus 315 € 390 €	standard plus 360 € 440 €	standard plus 405 € 500 €

## Acabados Finishes Finition



Los precios no incluyen IVA. Esta tarifa anula las anteriores.  
 Prices do not include VAT. This price list cancel and substitute the previous ones.  
 Les prix ne comprennent pas la TVA. Ce taux annule les précédents.

SHIRA Ref. 505

SHIRA Ref. 506

SHIRA Ref. 507

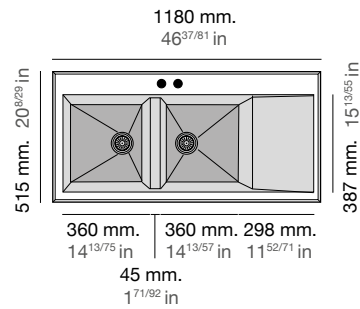
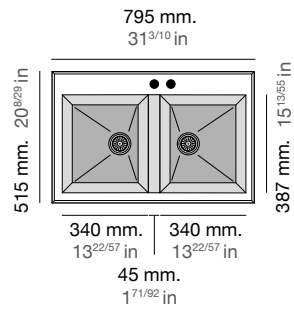
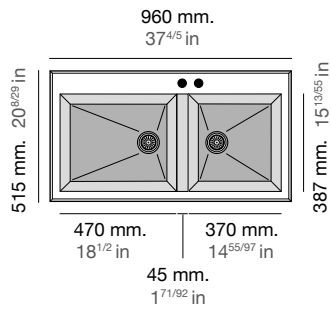

220 mm  
8<sup>43/65</sup> in

220 mm  
8<sup>43/65</sup> in

220 mm  
8<sup>43/65</sup> in

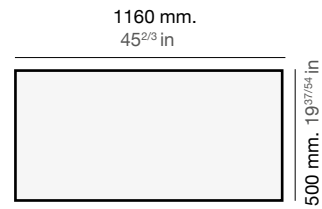
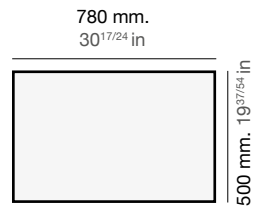
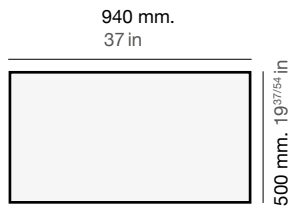

100 cm  
3<sup>15/16</sup> in

80 cm  
3<sup>9/20</sup> in

90 cm  
3<sup>25/48</sup> in

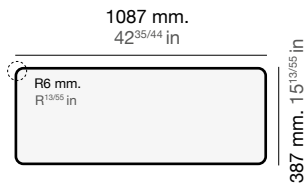
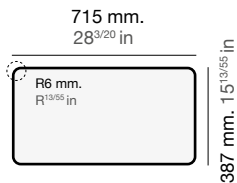
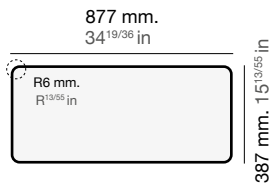

100 cm  
3<sup>15/16</sup> in

90 cm  
3<sup>25/48</sup> in

120 cm  
4<sup>71/96</sup> in

1.020 x 580 x 310 mm  
21,65 kg

860 x 580 x 310 mm  
19,7 kg

1.250 x 590 x 310 mm  
26,6 kg

40<sup>3/19</sup> x 22<sup>5/6</sup> x 12<sup>17/83</sup> in

33<sup>6/7</sup> x 22<sup>5/6</sup> x 12<sup>17/83</sup> in

49<sup>10/47</sup> x 23<sup>8/35</sup> x 12<sup>17/8</sup> in

standard plus  
455 € 560 €

standard plus  
360 € 440 €

standard plus  
470 € 580 €

Incluye  
Includes  
Inclus

Válvula redonda automática.  
Sifón y sellante.

Circular Automatic valve.  
Siphon and sealant.

Vanne automatique circulaire.  
Siphon et le colle mastic.

04 city  
collection

No renuncies al mejor diseño con los precios más competitivos. City es la más camaleónica de las colecciones de Poalgi. Sus líneas curvas añaden una elegante simplicidad a cada composición. Con infinidad de acabados, que aportan a nuestra colección un estilo adaptable a todo tipo de cocinas y estilos, siempre bajo la premisa de aportar calidad con el mejor coste.



Why not try one of the best designs with the most competitive prices City is the most chameleonic of Poalgi's collections. Its curved lines add an elegant simplicity to each composition. Poalgi offers you infinite finishes, which give our collection the adaptability to suite all types of kitchens and styles, always under the premise of providing quality at the best cost.

Simplicité et fonctionnalité. City constitue la gamme de produit la plus large des éviers Poalgi offrant une réponse à toute configuration et implantation de cuisine. Ses lignes courbes ajoutent une élégante simplicité à chaque composition.

Poalgi propose de nombreuses finitions apportant adaptabilité et polyvalence quel que soit le style choisi. Un produit simple... et toujours de grande qualité.

#### **Características** \_Characteristics \_Caractéristiques

<b>Roc Stone</b>	<b>Antibacteriano</b>	<b>Sobre encimera</b>
Roc Stone	Antibacterial	Inset
Roc Stone	Antibactérien	Sur plan de travail





# city<sub>323</sub>



CITY Ref. 323 Colorstandard\_CT\_Concret  
Finish\_ Gloss

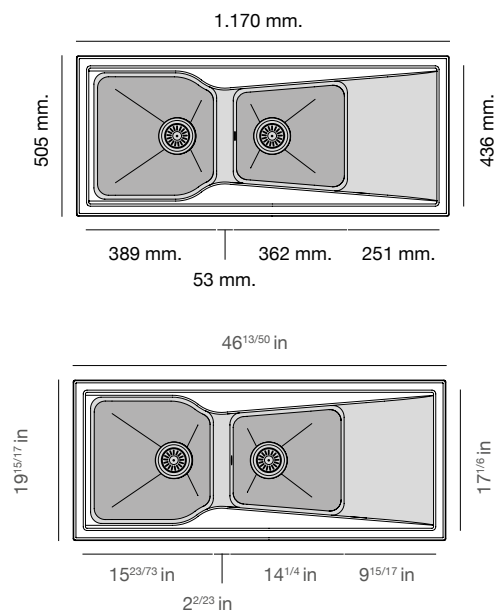





# city<sub>332</sub>



CITY Ref. 332 Colorstandard\_AL\_Albero  
Finish\_Soft

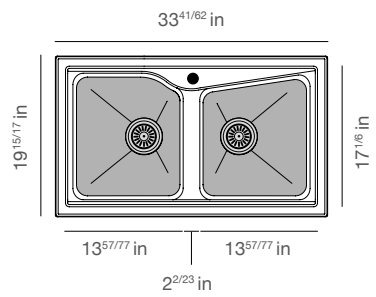
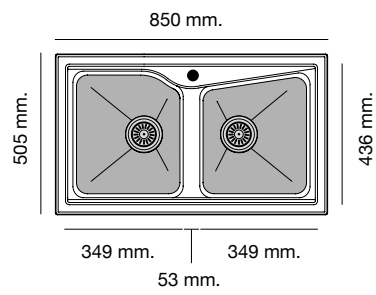

# city<sub>-330</sub>



CITY Ref. 330 Colorstandard\_TU\_Tundra  
Finish\_Soft

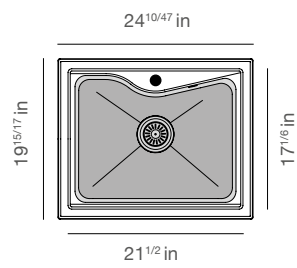
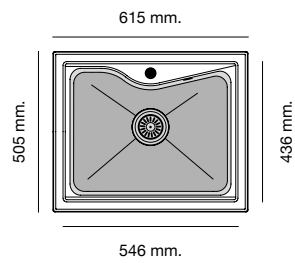





# city<sub>321</sub>



CITY Ref. 321 Colorstandard\_CT\_Concret  
Finish\_ Gloss

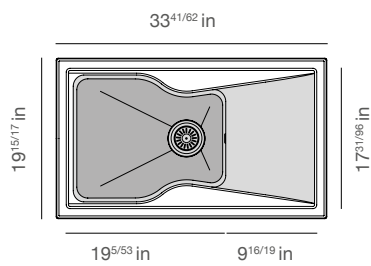
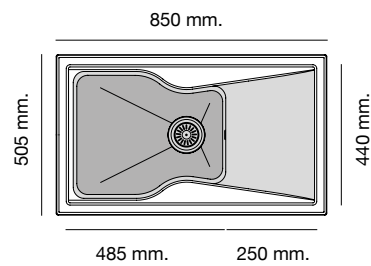



# 04 city collection

<b>Modelo</b>	CITY Ref. 320_ Gloss	CITY Ref. 321_ Gloss	CITY Ref. 322_ Gloss
<b>Model</b>	CITY Ref. 330_ Soft	CITY Ref. 331_ Soft	CITY Ref. 332_ Soft
<b>Modèle</b>			

<b>Medidas</b> Measurements Mesures			
---	--	--	--

<b>Profundidad cubeta</b> Bucket depth Profondeur de la cuve	220 mm 8 <sup>43/65</sup> in	220 mm 8 <sup>43/65</sup> in	220 mm 8 <sup>43/65</sup> in
--	---------------------------------	---------------------------------	---------------------------------

<b>Sobre encimera</b> Inset Sous plan de travail			
--	--	--	--

<b>Mueble</b> Furniture Meuble	60 cm 2 <sup>25/69</sup> in	70 cm 2 <sup>65/86</sup> in	90 cm 3 <sup>25/46</sup> in
--------------------------------------	--------------------------------	--------------------------------	--------------------------------

<b>Paquete</b> Packaging Colis	680 x 570 x 270 mm 10,75 kg 26 <sup>71/92</sup> x 22 <sup>15/34</sup> x 10 <sup>17/27</sup> in	920 x 570 x 270 mm 14,05 kg 36 <sup>13/59</sup> x 22 <sup>15/34</sup> x 10 <sup>17/27</sup> in	920 x 570 x 270 mm 15,7 kg 36 <sup>13/59</sup> x 22 <sup>15/34</sup> x 10 <sup>17/27</sup> in
--------------------------------------	--	--	---

<b>Tarifa</b> Price Tarif	Gloss	standard	plus	standard	plus	standard	plus
		200 €	250 €		240 €		295 €
Price Tarif	Soft	235 €	285 €	270 €	330 €	340 €	415 €

## Acabados

Finishes  
Finition



Los precios no incluyen IVA. Esta tarifa anula las anteriores.  
 Prices do not include VAT. This price list cancel and substitute the previous ones.  
 Les prix ne comprennent pas la TVA. Ce taux annule les précédents.

CITY Ref. 323\_ Gloss  
 CITY Ref. 333\_ Soft

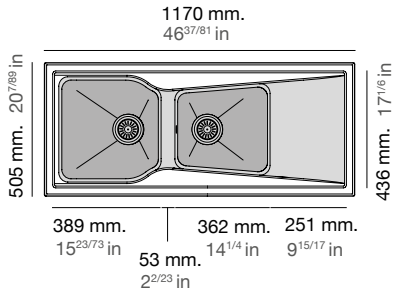

200 mm  
 7<sup>7/8</sup> in

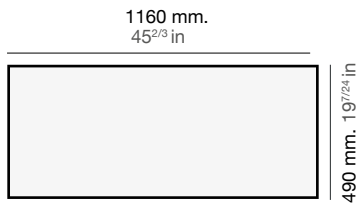

90 cm  
 3<sup>25/46</sup> in

1.200 x 570 x 270 mm  
 21,2 kg  
 49<sup>21/86</sup> x 22<sup>15/34</sup> x 10<sup>17/27</sup> in

standard	plus
335 €	410 €
385 €	475 €

Incluye  
 Includes  
 Inclus

Válvula circular.  
 Sifón y sellante.  
 Plantillas de encastre.  
 Incluye garras de anclaje

Circular valve.  
 Siphon and sealant.  
 Template inlay.  
 Including anchor claws

Vanne circulaire.  
 Siphon et le colle mastic.  
 Le gabarit d'encastrement.  
 Y compris les griffes d'ancrage

05 kuma  
collection

La estética industrial y urbana adquiere todo el sentido gracias a Kuma. Este modelo de cocina emerge como una de las tendencias más utilizadas para las viviendas modernas y de estilo vanguardista. El diseño depurado y los aires minimalistas que se respiran en las grandes urbes son las bases que inspiran la colección Kuma.



Industrial and urban aesthetic takes on a whole new meaning thanks to Kuma. This kitchen model is emerging as one of the most widely used trends for modern, avant-garde style homes. The purified design and the minimalist air that is breathed in the big cities are the bases that inspire the Kuma collection.

L'avant-gardisme acquiert tout son sens dans les lignes des éviers Kuma. Cette collection s'inspire des tendances actuelles et à venir pour être en harmonie la plus totale avec les maisons les plus modernes. Son design exclusif et ses formes inattendues font des éviers Kuma une collection des plus atypiques.

**Características** \_Characteristics \_Caractéristiques

<b>Roc Stone</b>	<b>Antibacteriano</b>	<b>Sobre encimera</b>
Roc Stone	Antibacterial	Inset
Roc Stone	Antibactérien	Sur plan de travail

KUMA Ref. 305 Colorstandard\_NL\_Negro Liso





# kuma<sub>306</sub>



KUMA Ref. 306 Colorstandard\_AL\_Albero

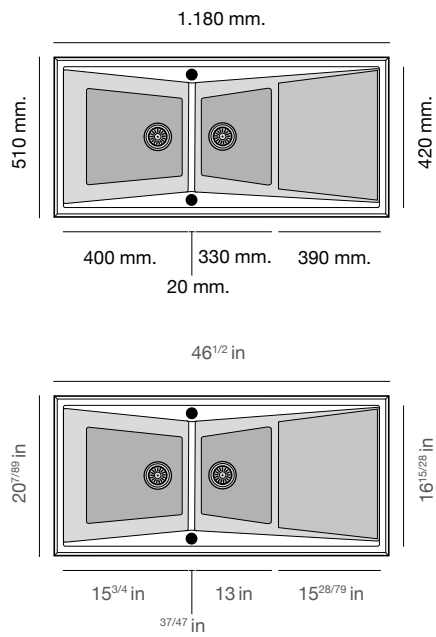

# kuma<sub>304</sub>



KUMA Ref. 304 Colorstandard\_PG\_Pergamon

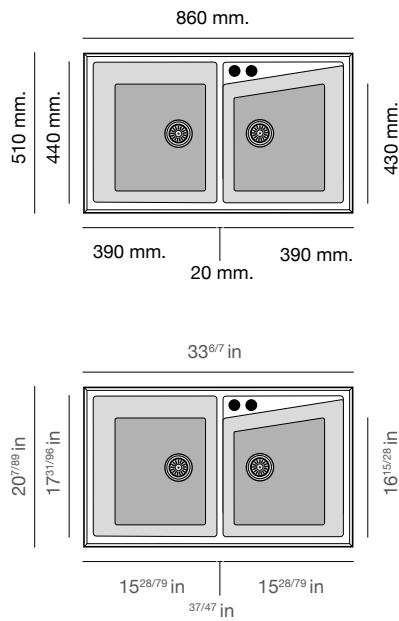











# kuma<sub>303</sub>

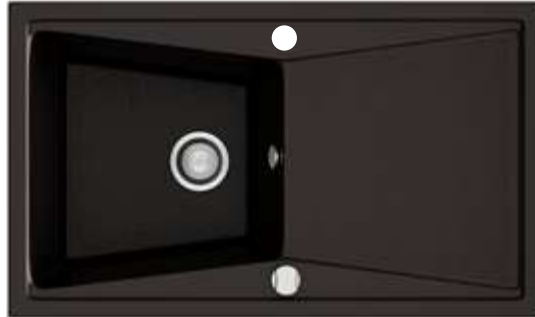

KUMA Ref. 303 Colorstandard\_BR\_Brown

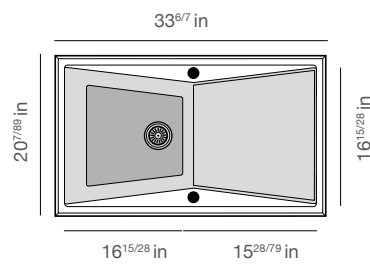
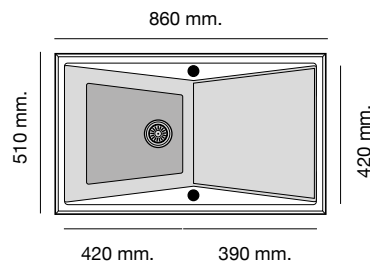

# kuma<sub>302</sub>



KUMA Ref. 302 Colorstandard\_BL\_Blanco

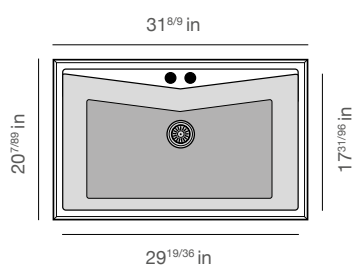
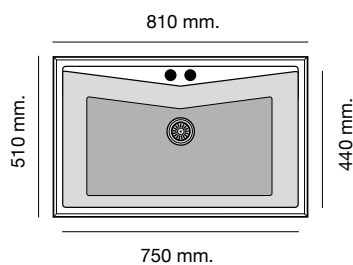



# 05 kuma collection

Modelo  
Model  
Modèle

KUMA Ref. 301

KUMA Ref. 302

KUMA Ref. 303

Medidas  
Measurements  
Mesures

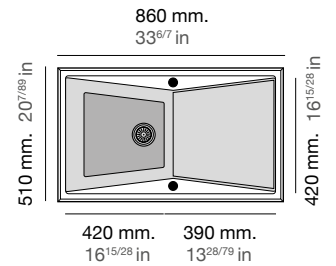
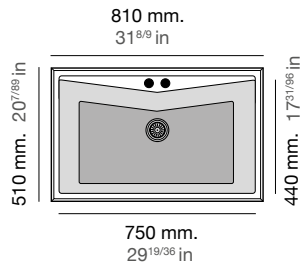
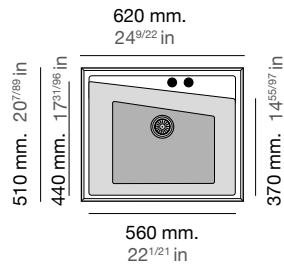

Profundidad cubeta  
Bucket depth  
Profondeur de la cuve

220 mm  
8<sup>43/65</sup> in

220 mm  
8<sup>43/65</sup> in

220 mm  
8<sup>43/65</sup> in

Sobre encimera  
Inset  
Sous plan de travail

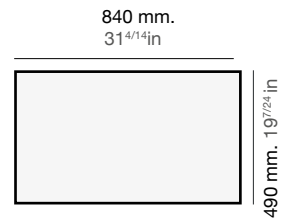
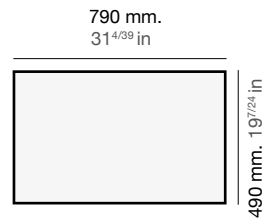
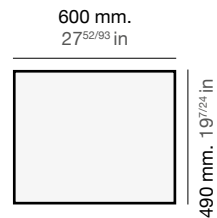

Mueble  
Furniture  
Meuble

60 cm  
2<sup>25/69</sup> in

80 cm  
3<sup>3/20</sup> in

50 cm  
1<sup>31/32</sup> in

Paquete  
Packaging  
Colis

690 x 570 x 310 mm  
12,4 kg  
27<sup>1/6</sup> x 22<sup>15/34</sup> x 12<sup>17/83</sup> in

880 x 570 x 310 mm  
14,5 kg  
34<sup>31/48</sup> x 22<sup>15/34</sup> x 12<sup>17/83</sup> in

930 x 570 x 310 mm  
15,8 kg  
36<sup>43/70</sup> x 22<sup>15/34</sup> x 12<sup>17/83</sup> in

Tarifa  
Price  
Tarif

Gloss  
standard plus  
295 € 365 €

standard plus  
340 € 415 €

standard plus  
335 € 410 €

Acabados  
Finishes  
Finition



Los precios no incluyen IVA. Esta tarifa anula las anteriores.  
 Prices do not include VAT. This price list cancel and substitute the previous ones.  
 Les prix ne comprennent pas la TVA. Ce taux annule les précédents.

KUMA Ref. 304

KUMA Ref. 305

KUMA Ref. 306

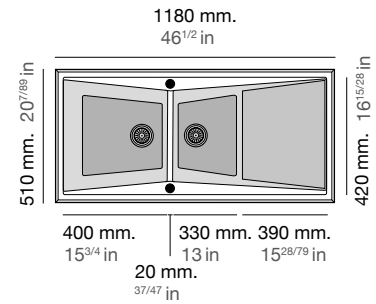
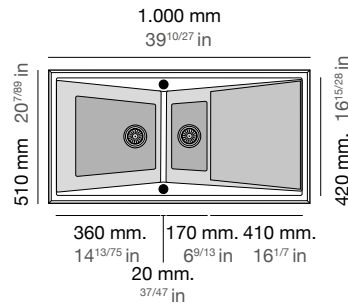
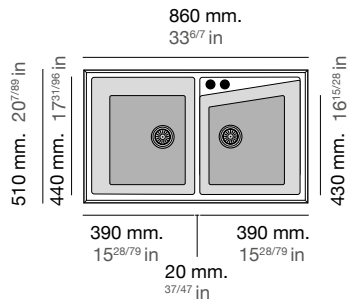

220 mm  
8<sup>43/65</sup> in

220 mm  
8<sup>43/65</sup> in

220 mm  
8<sup>43/65</sup> in

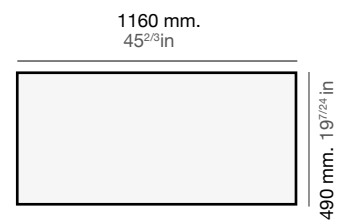
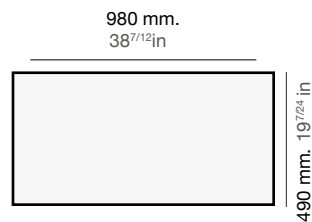
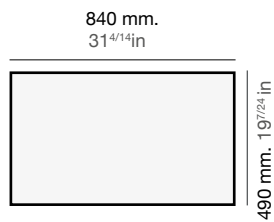

90 cm  
3<sup>25/48</sup> in

70 cm  
2<sup>65/86</sup> in

80 cm  
3<sup>9/20</sup> in

920 x 570 x 310 mm  
20,75 kg  
36<sup>13/59</sup> x 22<sup>15/34</sup> x 12<sup>17/83</sup> in

1070 x 570 x 310 mm  
16,1 kg  
42<sup>1/48</sup> x 22<sup>15/34</sup> x 12<sup>17/83</sup> in

1.240 x 570 x 310 mm  
23,1 kg  
48<sup>9/11</sup> x 22<sup>15/34</sup> x 12<sup>17/83</sup> in

standard plus  
395 € 490 €

standard plus  
420 € 520 €

standard plus  
470 € 580 €

Incluye  
Incluye  
Incluye

Válvula automática circular con maneta pulsador  
Sifón y sellante.  
Plantillas de encastre.  
Incluye garras de anclaje

Automatic circular valve with push-button handle  
Siphon and sealant.  
Template inlay.  
Including anchor claws.

Automatique vanne circulaire avec bouton poussoir.  
Siphon et le colle mastic.  
Le gabarit d'encastrement.  
Y compris les griffes d'ancrage





## 06 basic collection

Nuestra serie de fregaderos Basic es ideal para todas aquellas personas que busquen darle un aire retro a su cocina. Porque lo vintage está de moda, podrás encontrar en nuestros modelos el perfecto para ti.



Our Basic series of sinks is ideal for all those who want to give their kitchen a retro look. Because vintage is in fashion, you can find the perfect one for you across our models.

Notre collection d'éviers Basic est idéale pour toute personne recherchant à donner un style rétro à sa cuisine. Parce que le vintage est à la mode, vous pourrez trouver dans ces modèles celui qui vous conviendra parfaitement.

### **Características** \_Characteristics \_Caractéristiques

RocStone	Antibacteriano	Sobre encimera
RocStone	Antibacterial	Inset
RocStone	Antibactérien	Sur plan de travail

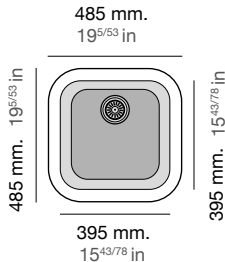
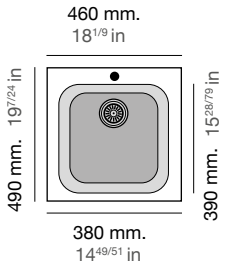
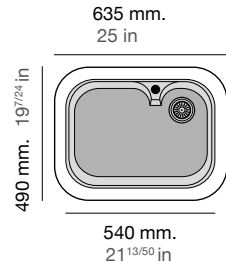
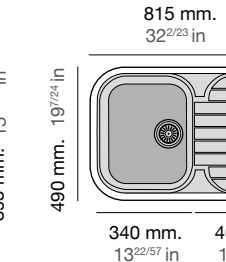
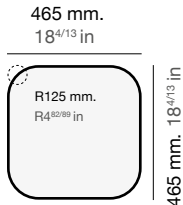
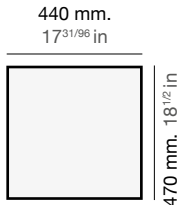
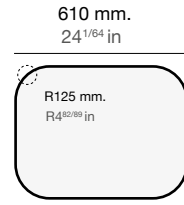
# 06 basic collection

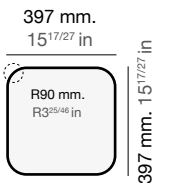
Modelo Model Modèle	ÁMBAR Ref. 152	TOBA Ref. 153	RUBÍ Ref. 105	CORAL Ref. 121
Medidas Measurements Mesures	 <p>485 mm. 19<sup>5/8</sup> in 395 mm. 15<sup>43/78</sup> in 395 mm. 15<sup>43/78</sup> in</p>	 <p>460 mm. 18<sup>1/8</sup> in 490 mm. 19<sup>7/24</sup> in 380 mm. 14<sup>49/51</sup> in 390 mm. 15<sup>28/79</sup> in</p>	 <p>635 mm. 25 in 490 mm. 19<sup>7/24</sup> in 540 mm. 21<sup>13/50</sup> in 395 mm. 15<sup>43/78</sup> in</p>	 <p>815 mm. 32<sup>2/23</sup> in 490 mm. 19<sup>7/24</sup> in 340 mm. 13<sup>22/57</sup> in 400 mm. 15<sup>3/4</sup> in 395 mm. 15<sup>43/78</sup> in</p>
Profundidad cubeta Bucket depth Profondeur de la cuve	170 mm 6 <sup>9/13</sup> in	170 mm 6 <sup>9/13</sup> in	170 mm 6 <sup>9/13</sup> in	180 mm 7 <sup>2/23</sup> in
Sobre encimera Inset Sous plan de travail	 <p>465 mm. 18<sup>4/13</sup> in R125 mm. R4<sup>82/89</sup> in 465 mm. 18<sup>4/13</sup> in</p>	 <p>440 mm. 17<sup>31/86</sup> in 470 mm. 18<sup>1/2</sup> in</p>	 <p>610 mm. 24<sup>1/64</sup> in R125 mm. R4<sup>82/89</sup> in 465 mm. 18<sup>4/13</sup> in</p>	 <p>800 mm. 31<sup>1/2</sup> in R125 mm. R4<sup>82/89</sup> in 475 mm. 18<sup>7/10</sup> in</p>
Mueble Furniture Meuble	45 cm 1 <sup>71/82</sup> in	45 cm 1 <sup>71/82</sup> in	60 cm 2 <sup>25/69</sup> in	45 cm 1 <sup>71/82</sup> in
Bajo encimera Undermount Sur plan de travail	 <p>397 mm. 15<sup>17/27</sup> in R90 mm. R3<sup>25/46</sup> in 397 mm. 15<sup>17/27</sup> in</p>			
Mueble Furniture Meuble	60 cm 2 <sup>25/69</sup> in			
Paquete Packaging Colis	530 x 490 x 230 mm 8,5 kg 20 <sup>13/15</sup> x 19 <sup>7/24</sup> x 9 <sup>1/18</sup> in	560 x 530 x 250 mm 8,5 kg 22 <sup>1/21</sup> x 20 <sup>13/15</sup> x 9 <sup>16/19</sup> in	690 x 500 x 230 mm 9,5 kg 27 <sup>1/6</sup> x 19 <sup>37/54</sup> x 9 <sup>1/18</sup> in	850 x 500 x 250 mm 9,5 kg 33 <sup>46/99</sup> x 19 <sup>37/54</sup> x 9 <sup>1/18</sup> in
Tarifa Price Tarif	standard plus Gloss 155 € 190 €	standard plus 170 € 210 €	standard plus 195 € 235 €	standard plus 205 € 255 €

## Acabados Finishes Finition



Los precios no incluyen IVA. Esta tarifa anula las anteriores.  
 Prices do not include VAT. This price list cancel and substitute the previous ones.  
 Les prix ne comprennent pas la TVA. Ce taux annule les précédents.

ESMERALDA Ref. 107

AMATISTA Ref. 119

MALAQUITA Ref. 108

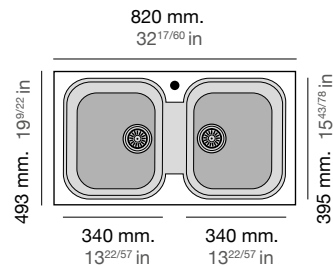
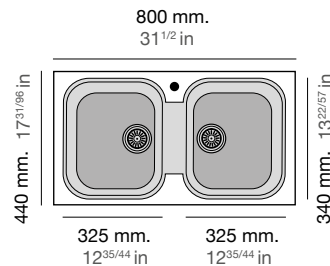
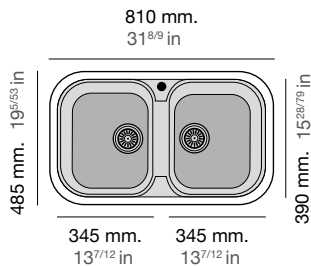

180 mm  
7<sup>2</sup>/<sub>23</sub> in

180 mm  
7<sup>2</sup>/<sub>23</sub> in

180 mm  
7<sup>2</sup>/<sub>23</sub> in

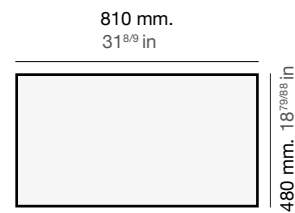
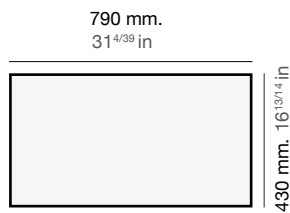
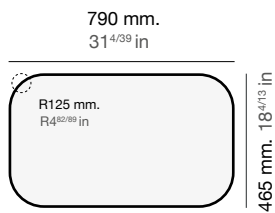

80 cm  
3<sup>3</sup>/<sub>20</sub> in

80 cm  
3<sup>3</sup>/<sub>20</sub> in

80 cm  
3<sup>3</sup>/<sub>20</sub> in

850 x 500 x 250 mm  
12,5 kg  
33<sup>46</sup>/<sub>99</sub> x 19<sup>37</sup>/<sub>54</sub> x 9<sup>16</sup>/<sub>19</sub> in

850 x 500 x 250 mm  
10 kg  
33<sup>46</sup>/<sub>99</sub> x 19<sup>37</sup>/<sub>54</sub> x 9<sup>16</sup>/<sub>19</sub> in

900 x 540 x 260 mm  
15 kg  
33<sup>13</sup>/<sub>30</sub> x 21<sup>13</sup>/<sub>50</sub> x 10<sup>13</sup>/<sub>55</sub> in

standard plus  
230 €    280 €

standard plus  
230 €    280 €

standard plus  
230 €    280 €

Incluye  
Includes  
Inclus

Válvula circular.  
Incluye garras de anclaje y plantillas de encastre.  
Los modelos Basic con escurridor se sirven sin orificio de grifo, para practicarlo indicar la posición del escurridor.

Circular valve.  
Including anchoring claws and inserts.  
The Basic models with drainer are supplied without tap hole, to be used to indicate the position of the drainer.

Vanne circulaire.  
Y compris les griffes d'ancrage et les inserts.  
Les modèles Basic avec égouttoir sont fournis sans trou de robinet, à utiliser pour indiquer la position de l'égouttoir.

# 06 basic collection

Modelo  
Model  
Modèle

TOPACIO Ref. 116

OLIVINO Ref. 120

DIAMANTE Ref. 106

Medidas  
Measurements  
Mesures

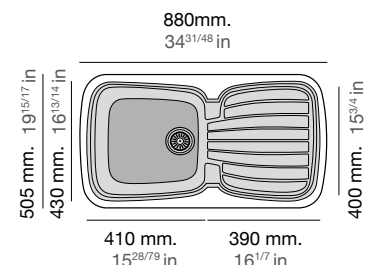
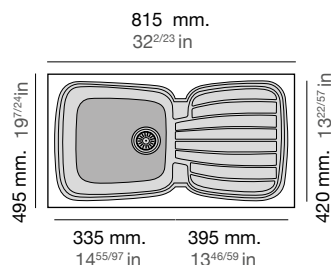
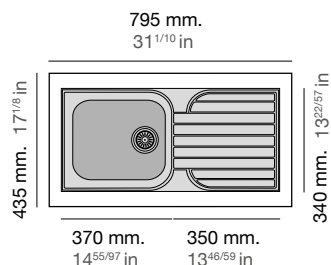

Profundidad cubeta  
Bucket depth  
Profondeur de la cuve

180 mm  
7<sup>2/23</sup> in

180 mm  
7<sup>2/23</sup> in

190 mm  
7<sup>12/25</sup> in

Sobre encimera  
Inset  
Sous plan de travail

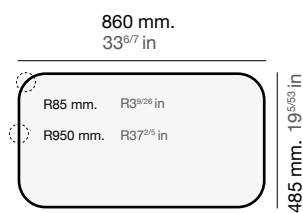
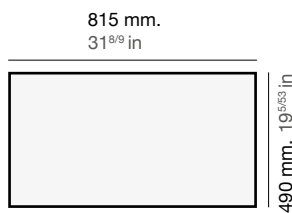
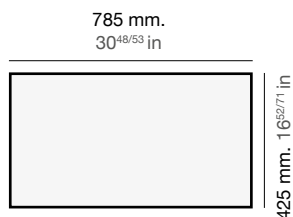

Mueble  
Furniture  
Meuble

50 cm  
1<sup>31/32</sup> in

45 cm  
1<sup>71/82</sup> in

60 cm  
2<sup>25/69</sup> in

Paquete  
Packaging  
Colis

850 x 500 x 250 mm  
12,5 kg  
33<sup>46/99</sup> x 19<sup>37/54</sup> x 9<sup>16/19</sup> in

530 x 490 x 230 mm  
4 kg  
20<sup>13/15</sup> x 19<sup>7/24</sup> x 9<sup>1/18</sup> in

900 x 540 x 260 mm  
13 kg  
35<sup>13/30</sup> x 21<sup>13/50</sup> x 10<sup>13/55</sup> in

Tarifa  
Price  
Tarif

standard plus  
Gloss 210 € 255 €

standard plus  
205 € 255 €

standard plus  
240 € 295 €

Acabados  
Finishes  
Finition



Los precios no incluyen IVA. Esta tarifa anula las anteriores.  
 Prices do not include VAT. This price list cancel and substitute the previous ones.  
 Les prix ne comprennent pas la TVA. Ce taux annule les précédents.

ÁGATA Ref. 102

JADE Ref. 118

ZAFIRO Ref. 104

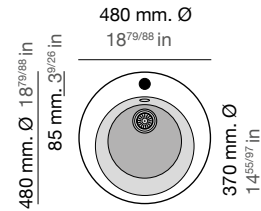
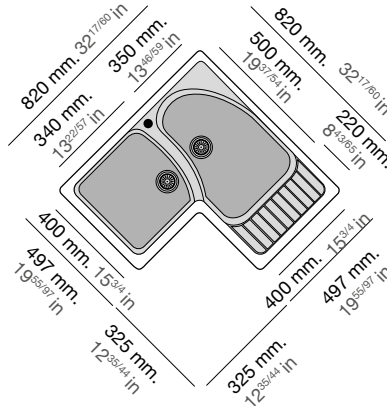
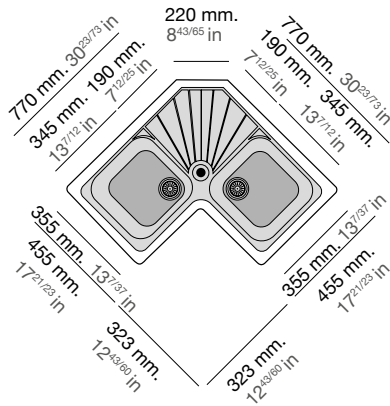

200 cm  
7<sup>7/8</sup> in

200 cm  
7<sup>7/8</sup> in

170 cm  
6<sup>9/13</sup> in

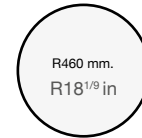
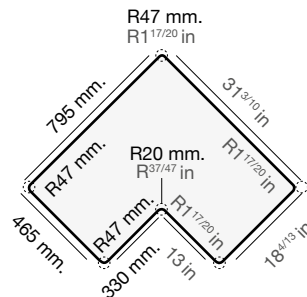
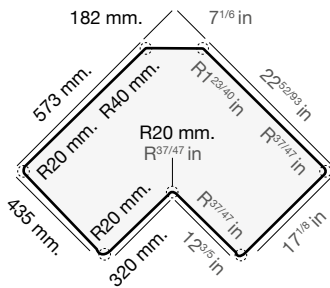

Mueble rincón 90 x 90 cm  
Corner furniture 3<sup>25/46</sup> x 3<sup>25/46</sup> in

Mueble rincón 90 x 90 cm  
Corner furniture 3<sup>25/46</sup> x 3<sup>25/46</sup> in

45 cm  
1<sup>7/8</sup> in

820 x 870 x 250 mm  
15,5 kg

32<sup>17/60</sup> x 34<sup>1/4</sup> x 9<sup>16/19</sup> in

820 x 870 x 250 mm  
18,5 kg

32<sup>17/60</sup> x 34<sup>1/4</sup> x 9<sup>16/19</sup> in

530 x 490 x 230 mm  
7,5 kg

20<sup>13/15</sup> x 19<sup>7/24</sup> x 9<sup>1/18</sup> in

standard plus  
305 € 375 €

standard plus  
305 € 375 €

standard plus  
155 € 190 €

Incluye  
Includes  
Inclus

Válvula circular.  
Incluye garras de anclaje y plantillas de encastre.  
Los modelos Basic con escurridor se sirven sin orificio de grifo, para practicarlo indicar la posición del escurridor.

Circular valve.  
Including anchoring claws and inserts.  
The Basic models with drainer are supplied without tap hole, to be used to indicate the position of the drainer.

Vanne circulaire.  
Y compris les griffes d'ancrage et les inserts.  
Les modèles Basic avec égouttoir sont fournis sans trou de robinet, à utiliser pour indiquer la position de l'égouttoir.

# 06 basic collection

Modelo  
Model  
Modèle

SÍLEX Ref. 117

CUARZO Ref. 103

Medidas  
Measurements  
Mesures

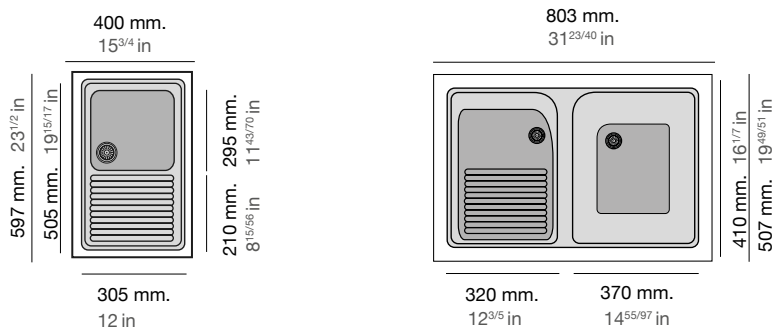

Profundidad cubeta  
Bucket depth  
Profondeur de la cuve

310 cm

12<sup>17/83</sup> in

320 cm escurridor 115 cm

12<sup>3/5</sup> in Dish dryeng rack 4<sup>48/91</sup> in

Sobre encimera  
Inset  
Sous plan de travail

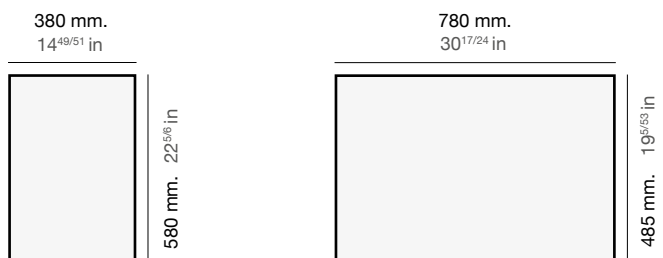

Mueble  
Furniture  
Meuble

40 cm

1<sup>23/40</sup>

80 cm

3<sup>3/20</sup>

Paquete  
Packaging  
Colis

450 x 350 x 735 mm  
6 kg

17<sup>43/60</sup> x 13<sup>46/59</sup> x 28<sup>15/16</sup> in

840 x 550 x 350 mm  
14 kg

33<sup>1/4</sup> x 21<sup>17/26</sup> x 13<sup>46/59</sup> in

Tarifa  
Price  
Tarif

standard plus

145 € 170 €

standard plus

225 € 275 €

Acabados  
Finishes  
Finition



Los precios no incluyen IVA. Esta tarifa anula las anteriores.  
Prices do not include VAT. This price list cancel and substitute the previous ones.  
Les prix ne comprennent pas la TVA. Ce taux annule les précédents.

Incluye  
Includes  
Inclus

Válvula circular.  
Incluye garras de anclaje y  
plantillas de encastrado.  
Los modelos Basic con  
escurridor se sirven sin orificio  
de grifo, para practicarle indicar  
la posición del escurridor.

Circular valve.  
Including anchoring claws and  
inserts.  
The Basic models with drainer are  
supplied without tap hole, to be  
used to indicate the position of the  
drainer.

Vanne circulaire.  
Y compris les griffes d'ancrage et les  
inserts.  
Les modèles Basic avec égouttoir sont  
fournis sans trou de robinet, à utiliser  
pour indiquer la position de l'égouttoir.





## <sup>07</sup> accessories collection

**Poalgi pone a tu disposición su colección de accesorios para personalizar tu fregadero. Desde nuestra grifería en diversos acabados hasta cestas escurrer platos, será la perfecta conjunción entre diseño y funcionalidad.**

Poalgi puts at your disposal its collection of accessories to personalize your sink. From our faucets in various finishes to dish drainer baskets, it will be the perfect combination of design and functionality.

Poalgi met à votre disposition sa collection d'accessoires pour personnaliser votre évier. De nos robinets en différentes finitions aux paniers égouttoirs à vaisselle, ce sera la combinaison parfaite de design et de fonctionnalité.

# grifería

Grifería de cocina monomando, cuerpo grifería en latón, cartucho monomando de 25mm., incluye latiguillos 50cms.

Single lever kitchen faucet, brass faucet body, 25mm. single lever cartridge, incl. 50cms hoses.

Robinet de cuisine à levier unique, corps de robinet en laiton, cartouche à levier unique de 25 mm, tuyaux de 50 cm inclus.





Ref. GCE039 138€

Grifería Poalgi acabado Cromo  
Poalgi faucet Chrome finish  
Robinet Poalgi fini Chromée



Ref. GCE039/NG 147€

Grifería Poalgi acabado Negro Mate  
Poalgi faucet Matte Black finish  
Robinet Poalgi fini Noir Mat



Ref. GCE039/OC 162€

Grifería Poalgi acabado Oro Cepillado  
Poalgi faucet Brushed Gold finish  
Robinet Poalgi fini Or Brossé



Ref. GCE039/ORC 159€

Grifería Poalgi acabado Oro Rosa Cepillado  
Poalgi faucet Brushed Rose Gold finish  
Robinet Poalgi fini Or Rose Brossé



Ref. GCE039/NQ 135€

Grifería Poalgi acabado Niquel Cepillado  
Poalgi faucet Brushed Nickel finish  
Robinet Poalgi fini Nickel Brossé



Ref. GCE039/BL 147€

Grifería Poalgi acabado Blanco  
Poalgi faucet White finish  
Robinet Poalgi fini Blanc

# Accesorios \_ Accessories \_ Accessoires

## Válvulas y sifones

## Basket Strainer Wastes and Traps

## Bondes et siphons

Cromo\_ chrome\_ chromée



Ref. 330 MT 8 €

Válvula sencilla con rebosadero.  
Modelo: Gandia/Basic  
Single Bowl Sink Basket Strainer Waste with Overflow.  
Model: Gandia/Basic.  
Bonde simple avec trop-plein  
Modèle: Gandia/Basic.



Ref. 350 MT 13 €

Válvula doble con rebosadero. Para fregadero de dos senos. Modelo: Basic  
Double Bowl Sink Basket Strainer Waste with Overflow  
Model: Basic  
Pour évier de 2 cuves.  
Modèle: Basic



Ref. POA030 30 €

Válvula automática extraplana un seno maneta pulsador.  
Modelo: Kuma/Shira  
Automatic extra-flat Basket Strainer Waste, Single-Bowl, push-button handle.  
Model: Kuma/Shira  
Bonde automatique extraplate une cuve avec bouton poussoir  
Modèle: Kuma/Shira



Ref. POA027 34 €

Válvula automática extraplana doble seno maneta pusador.  
Modelo: Kuma/Shira  
Automatic extra-flat Basket Strainer Waste, Double-Bowl, push-button handle.  
Model: Kuma/Shira  
Bonde automatique extraplate double cuve avec bouton poussoir  
Modèle: Kuma/Shira

Oro rosa\_ pink gold\_ or rose



Ref. POA038C 36 €

Válvula sencilla con rebosadero.  
Modelo: Gandia/Basic  
Single Bowl Sink Basket Strainer Waste with Overflow.  
Model: Gandia/Basic.  
Bonde simple avec trop-plein  
Modèle: Gandia/Basic.



Ref. POA040C 62 €

Válvula doble con rebosadero. Para fregadero de dos senos. Modelo: Basic  
Double Bowl Sink Basket Strainer Waste with Overflow  
Model: Basic  
Pour évier de 2 cuves.  
Modèle: Basic

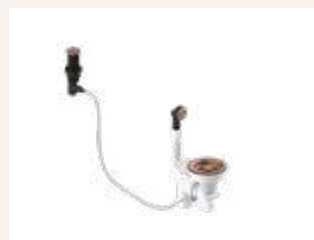

Ref. POA039C 64 €

Válvula automática extraplana un seno maneta pulsador.  
Modelo: Kuma/Shira  
Automatic extra-flat Basket Strainer Waste, Single-Bowl, push-button handle.  
Model: Kuma/Shira  
Bonde automatique extraplate une cuve avec bouton poussoir  
Modèle: Kuma/Shira



Ref. POA041C 88 €

Válvula automática extraplana doble seno maneta pusador.  
Modelo: Kuma/Shira  
Automatic extra-flat Basket Strainer Waste, Double-Bowl, push-button handle.  
Model: Kuma/Shira  
Bonde automatique extraplate double cuve avec bouton poussoir  
Modèle: Kuma/Shira

Oro\_ gold\_ or



Ref. POA038G 36 €

Válvula sencilla con rebosadero.  
Modelo: Gandia/Basic  
Single Bowl Sink Basket Strainer Waste with Overflow.  
Model: Gandia/Basic.  
Bonde simple avec trop-plein  
Modèle: Gandia/Basic.



Ref. POA040G 62 €

Válvula doble con rebosadero. Para fregadero de dos senos. Modelo: Basic  
Double Bowl Sink Basket Strainer Waste with Overflow  
Model: Basic  
Pour évier de 2 cuves.  
Modèle: Basic



Ref. POA039G 64 €

Válvula automática extraplana un seno maneta pulsador.  
Modelo: Kuma/Shira  
Automatic extra-flat Basket Strainer Waste, Single-Bowl, push-button handle.  
Model: Kuma/Shira  
Bonde automatique extraplate une cuve avec bouton poussoir  
Modèle: Kuma/Shira



Ref. POA041G 88 €

Válvula automática extraplana doble seno maneta pusador.  
Modelo: Kuma/Shira  
Automatic extra-flat Basket Strainer Waste, Double-Bowl, push-button handle.  
Model: Kuma/Shira  
Bonde automatique extraplate double cuve avec bouton poussoir  
Modèle: Kuma/Shira

Los precios no incluyen IVA. Esta tarifa anula las anteriores.

Prices do not include VAT. This price list cancel and substitute the previous ones

Los precios no incluyen IVA. Esta tarifa anula las anteriores.

Negro\_black\_noir



Ref. 330N 20 €

Válvula sencilla con rebosadero.  
Modelo: / Basic  
Single Bowl Sink Basket Strainer  
Waste with Overflow.  
Model: Gandia/Basic.  
Bonde simple avec trop-plein  
Modèle: Gandia et/ou Basic.



Ref. 350N 28 €

Válvula doble con rebosadero. Para fregadero de dos senos. Modelo: Basic  
Double Bowl Sink Basket Strainer Waste with Overflow  
Model: Basic  
Pour évier de 2 cuves.  
Modèle: Basic



Ref. POA030N 66 €

Válvula automática extraplana un seno maneta pulsador. Modelo: Kuma/Shira  
Automatic extra-flat Basket Strainer Waste, Single-Bowl, push-button handle.  
Model: Kuma/Shira  
Bonde automatique extraplate une cuve avec bouton poussoir  
Modèle: Kuma/Shira



Ref. POA027N 81 €

Válvula automática extraplana doble seno maneta pusador. Modelo: Kuma / Shira  
Automatic extra-flat Basket Strainer Waste, Double-Bowl, push-button handle.  
Model: Kuma/Shira  
Bonde automatique extraplate double cuve avec bouton poussoir  
Modèle: Kuma/Shira

Blanco\_white\_blanch



Ref. 330BL 20 €

Válvula sencilla con rebosadero. Modelo: Gandia/Basic  
Single Bowl Sink Basket Strainer Waste with Overflow.  
Model: Gandia/Basic.  
Bonde simple avec trop-plein  
Modèle: Gandia/Basic.



Ref. 350BL 28 €

Válvula doble con rebosadero. Para fregadero de dos senos. Modelo: Basic  
Double Bowl Sink Basket Strainer Waste with Overflow  
Model: Basic  
Pour évier de 2 cuves.  
Modèle: Basic



Ref. POA030BL 66 €

Válvula automática extraplana un seno maneta pulsador. Modelo: Kuma/Shira  
Automatic extra-flat Basket Strainer Waste, Single-Bowl, push-button handle.  
Model: Kuma/Shira  
Bonde automatique extraplate une cuve avec bouton poussoir  
Modèle: Kuma/Shira



Ref. POA027BL 81 €

Válvula automática extraplana doble seno maneta pusador. Modelo: Kuma/Shira  
Automatic extra-flat Basket Strainer Waste, Double-Bowl, push-button handle.  
Model: Kuma/Shira  
Bonde automatique extraplate double cuve avec bouton poussoir  
Modèle: Kuma/Shira

# Accesorios \_ Accessories \_ Accessoires

## Válvulas y sifones

## Basket Strainer Wastes and Traps

## Bondes et siphons

Cromo\_ chrome\_ chromée



Ref. POA005SA 29 €  
 Válvula cuadrada lúcida sencilla (personalizada). Modelo: Zie  
 Single Bowl Sink Lucid (customised). Model: Zie  
 Bonde carrée simple (personnalisée) Modèle : Zie



Ref. POA021SA 47 €  
 Válvula cuadrada lúcida doble (personalizada). Modelo: Zie  
 Double Bowl Sink Lucid Square Basket Strainer Waste (customised). Model: Zie  
 Bonde carrée double (personnalisée) Modèle : Zie



Ref. POA0315A 49 €  
 Válvula automática cuadrada maneta pulsador. Modelo: Kobus  
 Automatic Square Basket Strainer Waste, push-button handle. Model: Kobus  
 Bonde automatique carré avec bouton poussoir. Modèle: Kobus



Ref. POA0325A 68 €  
 Válvula automática cuadrada doble maneta pulsador (personalizada). Modelo: Kobus  
 Automatic Square Basket Strainer Waste with Double-Bowl push button handle (customised) Model: Kobus  
 Bonde automatique carrée double bouton poussoir (personnalisé) Modèle: Kobus

Oro rosa\_ pink gold\_ or rose



Ref. POA005C 54 €  
 Válvula cuadrada oro rosa sencilla (personalizada). Modelo: Zie  
 Single Bowl Sink Lucid (customised). Model: Zie  
 Bonde carrée simple (personnalisée) Modèle : Zie



Ref. POA021C 100 €  
 Válvula cuadrada lúcida doble (personalizada). Modelo: Zie  
 Double Bowl Sink Lucid Square Basket Strainer Waste (customised). Model: Zie  
 Bonde carrée double (personnalisée) Modèle : Zie



Ref. POA031C 85 €  
 Válvula automática cuadrada maneta pulsador. Modelo: Kobus  
 Automatic Square Basket Strainer Waste, push-button handle. Model: Kobus  
 Bonde automatique carré avec bouton poussoir. Modèle: Kobus



Ref. POA032C 127 €  
 Válvula automática cuadrada doble maneta pulsador (personalizada). Modelo: Kobus  
 Automatic Square Basket Strainer Waste with Double-Bowl push button handle (customised) Model: Kobus  
 Bonde automatique carrée double bouton poussoir (personnalisé) Modèle: Kobus

Oro\_ gold\_ or



Ref. POA005G 54 €  
 Válvula cuadrada oro rosa sencilla (personalizada). Modelo: Zie  
 Single Bowl Sink Lucid (customised). Model: Zie  
 Bonde carrée simple (personnalisée) Modèle : Zie



Ref. POA021G 100 €  
 Válvula cuadrada lúcida doble (personalizada). Modelo: Zie  
 Double Bowl Sink Lucid Square Basket Strainer Waste (customised). Model: Zie  
 Bonde carrée double (personnalisée) Modèle : Zie



Ref. POA031G 85 €  
 Válvula automática cuadrada maneta pulsador. Modelo: Kobus  
 Automatic Square Basket Strainer Waste, push-button handle. Model: Kobus  
 Bonde automatique carré avec bouton poussoir. Modèle: Kobus



Ref. POA032G 127 €  
 Válvula automática cuadrada doble maneta pulsador (personalizada). Modelo: Kobus  
 Automatic Square Basket Strainer Waste with Double-Bowl push button handle (customised) Model: Kobus  
 Bonde automatique carrée double bouton poussoir (personnalisé) Modèle: Kobus

Los precios no incluyen IVA. Esta tarifa anula las anteriores.  
 Prices do not include VAT. This price list cancel and substitute the previous ones  
 Los precios no incluyen IVA. Esta tarifa anula las anteriores.



Ref. 310 6 €

Válvula lavaderos.  
 Modelo: Cuarzo/Silex (Basic)

Laundry Sink Basket Strainer.  
 Modelo: Cuarzo/Silex (Basic)

Bonde lavoirs.  
 Modèle: Cuarzo/Silex (Basic)



Ref. 213 16 €

Sifón triple. Con conexión  
 adicional lavavajillas.

Triple-Bowl Sink Trap with  
 additional dishwasher  
 connection.

Siphon triple. Avec connexion  
 additionnel pour lave-vaisselle



Ref. 212 7 €

Sifón doble. Con conexión  
 adicional lavavajillas.

Double-Bowl Sink Trap  
 with additional dishwasher  
 connection.

Siphon double. Avec connexion  
 additionnel pour lave-vaisselle



Ref. 211 3 €

Sifón individual. Con conexión  
 adicional lavavajillas.

Single-Bowl Sink Trap  
 with additional dishwasher  
 connection.

Siphon simple. Avec connexion  
 additionnel pour lave-vaisselle



Sencilla 670\_MER\_SM 18 €  
 Doble 675\_MER\_SM 32 €

Válvula oculta latón cromado  
 Sencilla o doble.

Chromed Brass Concealed  
 Basket Strainer Waste

Bonde occulte en laiton chromé.  
 Ref.

Simple 670\_MER\_SM  
 Double 675\_MER\_SM



# Accesorios \_Accessories \_Accessoires



Los precios no incluyen IVA. Esta tarifa anula las anteriores.  
Prices do not include VAT. This price list cancel and substitute the previous ones  
Los precios no incluyen IVA. Esta tarifa anula las anteriores.



Ref. TCZ                      TCZ1 93€  
   TCZ2 78€

Tabla de corte de polímero técnico

Technical polymer cutting board.

Planche à découper en polymère technique.



Ref. A888/C                      35€

Dispensador de jabón. (Válido para todos los modelos de este catálogo)

Soap Dispenser. (valid for all models in this catalogue)

Distributeur de savon. (Valable pour tous les modèles de ce catalogue)



Ref. ACC16                      50€

Cesta escurreplatos acero inoxidable. Modelo: Gandia

Stainless Steel Dish Drying Rack. Model: Gandia

Panier égouttoir en acier inoxydable. Modèle: Gandia



Ref. ACC17                      50€

Cesta escurreplatos acero inoxidable. Modelo: Zie

Stainless Steel Dish Drying Rack. Model: Zie

Panier égouttoir en acier inoxydable. Modèle: Zie

# Uso y mantenimiento

\_ Use and maintenance

\_ Utilisation et entretien

## Recomendaciones

Recommendations

Conseils



**No se deben utilizar** sustancias fuertemente alcalinas como el **amoniaco** o **sosa cáustica**, ni **productos industriales**, productos de limpieza que se hayan mezclado y **desinfectantes** que contengan **ácidos**. No verter **pinturas decorativas**, ni **tintes** u otras sustancias colorantes. En caso de hacerlo aclarar con abundante agua y seguir los pasos de mantenimiento y limpieza.

Strong alkaline substances such as ammonia or caustic soda, industrial products, cleaning products that have been mixed and disinfectants containing acids must not be used.

Do not pour decorative paints, dyes or other colouring substances. In case of doing so, rinse with plenty of water and follow the maintenance steps advised.

Ne pas utiliser des substances fortement alcalines comme l'ammoniaque ou la soude caustique, des produits industriels, des produits de nettoyage mélangés et des désinfectants contenant de l'acide. Ne pas verser de peintures, de colorants, ou autres substances colorantes. Dans le cas contraire, rincer abondamment et suivre précisément les étapes concernant l'entretien et le nettoyage.



El **uso indebido** de las **alfombrillas** antideslizantes en el fregadero pueden ocasionar daños en las superficies. Si las dejamos durante largos periodos de tiempo se produce una constante retención de agua. A largo plazo puede producirse un efecto de tipo **bambollas** muy característico. **No descongeler productos** sobre la superficie del fregadero.

Improper use of anti-slip mats in the sink can cause damage to the surfaces. If left for long periods of time, there is a constant retention of water which over time creates a blister-type effect.

Do not thaw products on the sink surface.

L'utilisation inappropriée de tapis antidérapants dans l'évier peut endommager les surfaces. S'ils ne sont pas retirés pendant de longues périodes, la rétention d'eau induite peut provoquer dans le temps l'apparition d'imperfections caractérisées. Ne pas décongeler des produits directement sur la surface de l'évier.



**No usar** estropajos de acero tipo "**Nanas**", utilizar esponjas, paños suaves o estropajos "**no raya**". **No tapar** u obstruir el **rebosadero**.

Do not use strong scourer. Instead use sponges, soft cloths or "non-scratch" pads. Do not cover or block the sink overflow.

Ne pas utiliser des produits d'entretien de type laine d'acier. Utiliser éponges, chiffons doux ou lavettes anti-rayures. Ne pas couvrir ou obstruer le trop-plein.



**No golpear con objetos, ni usar útiles cortantes y/o punzantes sobre el fregadero.**

Do not hit with objects or use sharp and/or pointed tools on the sink.

Ne pas entrecroquer l'évier avec des objets, ne pas utiliser d'outils coupants directement sur l'évier.



**No colocar objetos recién retirados del fuego. No verter aceites o líquidos similares hirviendo.**

Do not place objects that have just been removed from the stove. Do not spill boiling oils or any other similar liquids.

Ne pas poser sur l'évier tout objet venant d'être sorti du four. Ne pas verser d'huile ou liquides similaires encore chauds.

### Suciedad en fondo y manchas eventuales

Dirt on the bottom and possible stains

Salissure importante et tâches eventuelles



Si con el paso del tiempo el fregadero acumula suciedad en el fondo o perduran las manchas, seguir las siguientes recomendaciones:

1. Dejar reposar durante **un par de horas** con agua y abundante **lejía**.
2. Aclarar con agua y **frotar con un cepillo** de púas vegetales o de plástico. En caso de que permanezcan las manchas, repetir la operación dejando reposar más horas y añadir más lejía.

Una limpieza diaria mantendrá su fregadero limpio durante toda su vida.

If over time the sink accumulates dirt on the bottom or stains persist, follow the recommendations below:

1. Let it stand for a couple of hours with water and plenty of bleach.
2. Rinse with water and scrub with a vegetable or plastic brush. If the stains remain, repeat the operation and let stand for a few more hours and add more bleach.

Daily cleaning will keep your sink clean for a lifetime.

Si dans le temps, une accumulation de salissure se dépose dans le fond de cuve ou des tâches perdurent, suivre les conseils suivants :

1. Remplir la cuve d'eau et d'eau de javel et laisser reposer pendant 2 heures.
2. Rincer à l'eau et frotter avec une brosse végétale ou plastique. Si les tâches persistent, répéter plus longuement l'opération de trempage et ajouter une quantité supérieure d'eau de javel.

Un nettoyage quotidien préservera l'évier dans un aspect optimal.

# Uso y mantenimiento \_ Use and maintenance \_ Utilisation et entretien

## Limpieza diaria Daily cleaning Entretien quotidien

---



Usar una esponja con **jabón lavavajillas y agua**, aclarar con agua y secar con un trapo. Esta acción mantendrá su fregadero limpio durante toda su vida útil.

Use a sponge with dishwashing soap and water, rinse with water and dry with a cloth. This action will keep your sink clean throughout its lifetime.



Utiliser une éponge avec du liquide vaisselle et de l'eau, rincer à l'eau et sécher avec un chiffon. Ainsi, l'aspect de l'évier restera optimal.





#### Manchas eventuales

Usar un trapo empapado con **lejía** y agua tibia. También es válido usar **disolventes universales** y posteriormente secar con un trapo. Según el tipo de mancha usaremos un disolvente de mayor o menor grado de pureza, como pueda ser la **acetona** y el **quitaesmalte**.

#### Possible stains

Use a cloth soaked in bleach and warm water. It is also valid to use universal solvents and then dry with a cloth. Depending on the type of stain, we will use a solvent of a greater or lesser degree of purity, such as acetone or nail polish remover.



#### Eventuelles tâches

En cas de taches, utiliser un chiffon imbibé d'eau de javel et d'eau chaude. Il est également possible d'utiliser un dissolvant universel, puis sécher avec un chiffon. Selon le type de tache, utiliser un dissolvant (acétone...) avec un niveau de pureté plus ou moins élevé, comme de l'acétone ou du démaquillant.



#### Manchas de vino y/o café

Se recomienda limpiar los líquidos muy penetrantes, como el **café** o el **vino**, con un **bayeta** húmeda antes de que se sequen.

#### Wine and/or coffee stains

It is recommended to clean very penetrating liquids such as coffee or wine with a damp cloth before they dry.



#### Tâches de café ou de vin

Nettoyer les liquides très pénétrants, comme le café ou le vin avec un chiffon avant séchage.



#### Manchas de cal

Para eliminarlas basta con aplicar **limón** o **vinagre disueltos en agua**.

#### Lime stains

To remove it, simply apply lemon or vinegar dissolved in water.

#### Tâches de calcaire

Pour éliminer les tâches de calcaire, appliquer du citron ou du vinaigre dissous dans l'eau.

## Hekla

---

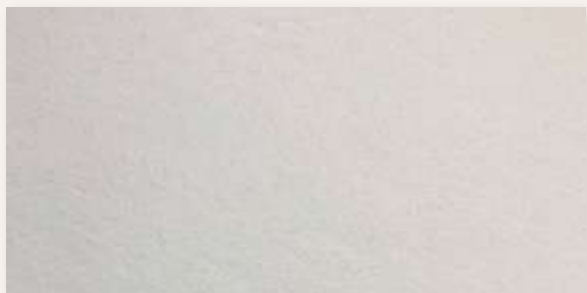

SW\_Snow



PU\_Pumice



AS\_Ash



BS\_Basalt

**Roc Stone / Roc Glass**

---

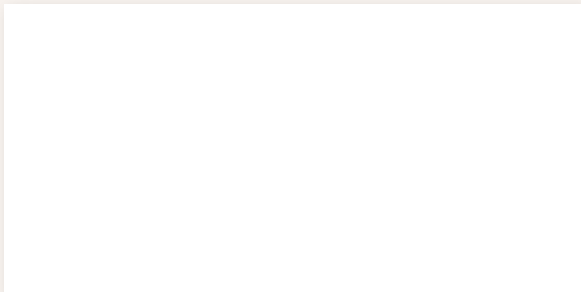

BL\_ Blanco

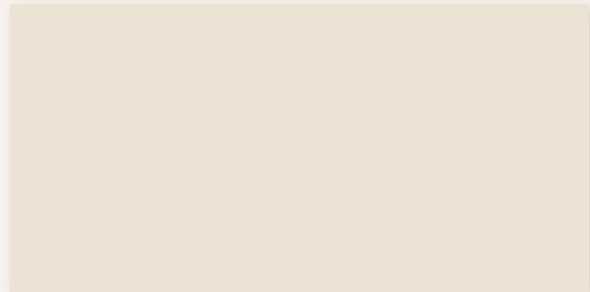

PG\_ Pergamón



AL\_ Albero



CT\_ Concret

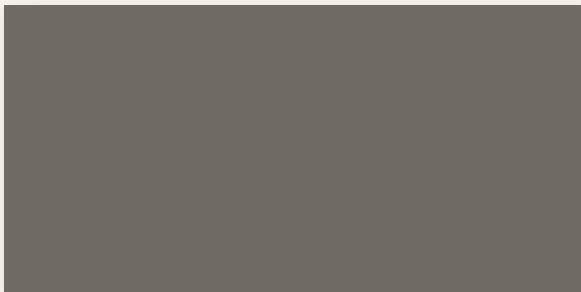

TU\_ Tundra

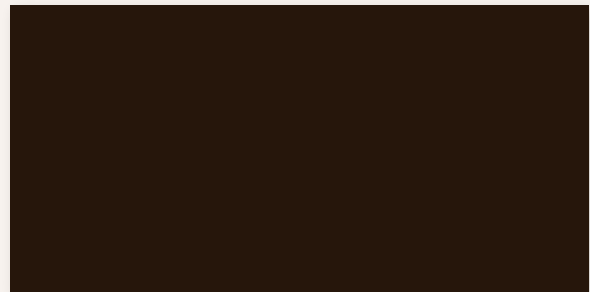

BR\_ Brown

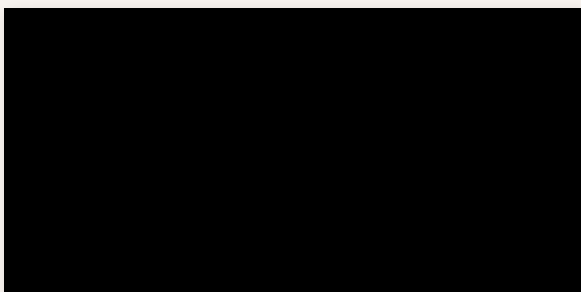

NL\_ Negro Liso





Hekla® es nuestro nuevo material. 30 años de investigación dan como resultado un material en masa resistente a todos los factores externos. Inspirado en la fuerza de la naturaleza, Hekla® es para siempre. Series: Kobus, Zie, Gandia y City.

Hekla® is our new material. 30 years of research result in a mass material resistant to all external factors. Inspired by the forces of nature, Hekla® is forever. Series: Kobus, Zie, Gandia and City.

Hekla® est notre nouveau matériau. 30 années de recherche ont donné comme résultat un matériau en masse résistante à tous les facteurs extérieurs. Inspiré de la force de la nature, Hekla est éternel. Séries: Kobus, Zie et Gandia.

## Datos técnicos \_ Technical data \_ Données techniques

### Resistencias \_ Resistance \_ Résistance

### Método \_ Method \_ Méthode

Rayado\_ Scratch\_ Rayures  
Abrasión\_ Abrasion\_ Abrasion

UNE-EN 13310  
UNE-EN 13310

Sin cambios\_ No changes\_ Sans changement  
Sin cambios\_ No changes\_ Sans changement

Hongos\_ Fungi\_ Champignons:

- Aspergillus niger van Tieghem ATCC 6275
- Penicillium funiculosun Thom CMI 114933
- Paecilomyces variotii Bainier ATCC 18502
- Gliocadium virens Miller et al. ATCC 9645
- Chaetomium globosum Kunze: Fries ATCC 6205

ISO 846:2019

Apto\_ suitable\_Apte  
Apto\_ suitable\_Apte  
Apto\_ suitable\_Apte  
Apto\_ suitable\_Apte  
Apto\_ suitable\_Apte

Bacterias\_ Bacteria\_ Bactéries:

- Gram-negativa Pseudomonas aeruginosa ATCC13388.

Apto\_ suitable\_Apte

Calor\_ Heat\_ Chaleur:  
185°

UNE-EN 13310

Sin cambios\_ No changes\_ Sans changement

Agentes químicos y colorantes\_ Chemical and coloring agents\_Agents chimiques y colorants:

- Ácido acético\_ Acetic acid \_ Acide acétique (10%)
- Hidróxido sódico \_ Sodium hydroxide Hydroxyde sodique (5%)
- Etanol\_ Ethanol\_ Ethanol( (70%)
- Lejía\_ Bleach\_ Javel
- Azul de metileno\_ Methylene blue\_ Bleu de méthylène (1%)
- Cloruro sódico\_ Sodium chloride\_ Chlorure sodique (85 g/litro)

UNE-EN 13310

Sin cambios\_ No changes\_ Sans changement  
Sin cambios\_ No changes\_ Sans changement  
Sin cambios\_ No changes\_ Sans changement  
Sin cambios\_ No changes\_ Sans changement  
Sin cambios\_ No changes\_ Sans changement  
Sin cambios\_ No changes\_ Sans changement

# Roc Stone®

## poalgi

Fruto del esfuerzo en I+D+i, Poalgi ha desarrollado un composite a base de resinas y un alto porcentaje en cargas minerales de alta resistencia y gran durabilidad que nos permite diseñar nuestros fregaderos sin limitaciones técnicas y con un gran acabado superficial. Series: Zie, Gandia, Shira, Kuma, City y Basic.

### Bactiblock®

Es un aditivo antimicrobiano que poseen todas las colecciones, idóneo para una amplia variedad de materiales poliméricos. La tecnología patentada por NBM está basada en arcilla funcionalizada con plata, comportándose como una fuente natural, altamente eficaz como agente antimicrobiano. Este aditivo inhibe el crecimiento de bacterias hongos y levaduras, siendo por tanto una herramienta muy eficaz frente a olores y manchas.

As a result of our efforts in R&D, Poalgi has developed a composite based on resins and a high percentage of mineral fillers of high resistance and great durability that allows us to design our sinks without technical limitations and with a great surface finish. Series: Zie, Gandia, Shira, Kuma, City y Basic.

### Bactiblock®

It is an antimicrobial additive included in all collections, suitable for a wide variety of polymeric materials. NBM's patented technology is based on clay functionalized with silver, behaving as a natural source, highly effective as an antimicrobial agent. This additive inhibits the growth of bacteria, fungi and yeasts, making it a highly effective tool against odors and stains.

Fruit de notre département R&D, Poalgi a développé un composite à base de résines et de charges minérales en haute proportion, offrant une haute résistance et grande durabilité et permettant de concevoir des éviers sans limites techniques et avec une parfaite finition de surface. Séries: Zie, Gandia, Shira, Kuma, City y Basic.

### Bactiblock®

Ce procédé et un additif antimicrobien idéal pour une large variété de matériaux polymères. La technologie brevetée par la société NBM repose sur une argile fonctionnalisée avec de l'argent, laquelle va se comporter comme une source naturelle hautement efficace comme agent microbien. Cet additif inhibe le développement des bactéries de type champignon et levure, se convertissant ainsi en une solution efficace contre les odeurs et les tâches.

**Datos técnicos** \_ Technical data \_ Données techniques

### Resistencias

 \_ Resistance \_ Résistance

Resistencia al impacto_ Impact resistance_ Résistance à l'impact	12 kgf/m2
Resistencia a la compresión_ Resistance to compression_ Résistance à la compression	1 595 kgf/m2
Resistencia a la flexión_ Flexural strength_ Résistance à la flexion	5 110 MPA
Resistencia térmica_ Thermal resistance_ Résistance thermique	130 oC
Dureza barcol (935)_ Barcol hardness _ Dureté barcol	45

Resistencia al manchado\_ Resistance to marking\_ Dureté barcol:

- Con ácido clorhídrico_ With hydrochloric acid_ Avec acide chlorhydrique	0,3
- Con detergentes_ With detergents_ Avec détergent	Sin cambios_ No changes_ Sans changement
- Con anticálceos _ With anti-scale_ Avec anticalcaires	Sin cambios_ No changes_ Sans changement
- Con amoníaco_ With ammonia_ Avec ammoniac	Cambio moderado_ Moderate change_ Changement modéré

# Materiales

\_ Materials \_ Matériaux

Estudio técnico de calidad efectuado:

AIMPLAS – Instituto Tecnológico del Plástico (Informe AT-0819/13 de 29/07/2013)

Declaración de conformidad

Poalgi, S.L. declara que los productos que fabrican son conformes al anexo ZA de la norma: UNE-EN 13310:2003 Fregaderos de cocina.

Requisitos funcionales y Métodos de ensayo.

Technical quality study carried out by:

AIMPLAS\_Technological Institute of Plastic (Report AT-0819/13 of 29/07/2013).

Declaration of conformity

Poalgi S.L. declares that the products they manufacture conform to annex ZA of the UNE-EN 13310:2003 kitchen sinks standard.

Functional requirements and test methods.

Etude technique qualité réalisée par:

AIMPLAS\_ Institut des plastiques techniques (Rapport AT-0819/13 de 29/07/2013)

Déclaration de conformité

Poalgi, S.L. déclare que les produits qu'elle fabrique sont conformes à l'annexe ZA de la norme : UNE-EN 13310:2003 Eviers de cuisine.

Prérequis fonctionnels et méthodes de tests.

## Garantía de calidad Quality Guarantee Garantie de qualité

Cada fregadero se somete a un riguroso control durante las distintas fases de fabricación por lo cual podemos indicar que son mínimas las incidencias en las que haya que hacer uso de la garantía por parte del consumidor. Avalado por el sistema de calidad ISO 9001.

Poalgi ofrece 5 años de garantía para sus fabricados en Roc\_Glass® y Roc\_Stone® y Hekla® en las condiciones que detallamos:

1. La garantía tiene efecto desde la fecha de adquisición por parte del consumidor del producto.
2. Poalgi durante este periodo se hace cargo de cualquier defecto de fabricación, roturas por variaciones térmicas e irregularidades en el material. Estaría exento de garantía: las roturas producidas por impacto violento o el deterioro del material producido por un uso inadecuado, una instalación incorrecta, reparaciones no autorizadas, aplicaciones de productos corrosivos.
3. Poalgi se encargará de reparar o reemplazar el fregadero a través del establecimiento donde fue adquirido (nunca el reembolso económico). Para ello será necesario acompañar el documento acreditativo de la compra junto con la ficha de Garantía debidamente cumplimentada y, una vez analizada, el departamento técnico confirmará la aceptación si se encuentra dentro de los supuestos que cubre dicha garantía.

La garantía queda limitada a la reparación adecuada del producto o sustitución de la pieza defectuosa, reconocida por el departamento de control de calidad sin cubrir gastos de su nueva instalación y sin que el comprador pueda, en ningún caso, solicitar indemnización alguna por sus daños ocasionados, ni directa ni indirectamente.

No se admiten cambios ni devoluciones.

Each sink is subjected to a rigorous control during the different stages of manufacture, which is why we can say that there are very few incidents in which the consumer has to make use of the guarantee. Endorsed by the ISO 9001 quality system, Poalgi offers a 5-year guarantee for its Roc\_Glass® and Roc\_Stone® and Hekla® products under the following conditions:

1. The guarantee takes effect from the date of purchase of the product by the consumer.
2. During this period, Poalgi is responsible for any manufacturing defect, breakage due to thermal variations and irregularities in the material. Any breakage caused by violent impact or deterioration of the material caused by improper use, incorrect installation, unauthorised repairs or the application of corrosive products shall be exempt from the guarantee.
3. Poalgi will repair or replace the sink through the establishment where it was purchased (never economic reimbursement). To do so, it will be necessary to accompany the document certifying the purchase together with the duly completed warranty form and, once it has been analysed, the technical department will confirm acceptance if it falls within the cases covered by the said warranty.

The warranty is limited to the appropriate repair of the product or replacement of the defective part, recognised by the quality control department, without covering the cost of its new installation and without the purchaser being able, under any circumstances, to request any compensation for the damage caused, either directly or indirectly.

No exchanges or returns are admitted.

Chaque évier est soumis un rigoureux contrôle durant les différentes phases de fabrication. De fait, les incidents impliquant la garantie du fabricant sont minimes. Approuvé par le système de qualité ISO 9001.

Poalgi offre 5 ans de garantie pour ses fabrications en Roc\_Glass® et Roc\_Stone® et Hekla® dans les conditions mentionnées ci-dessous :

1. La garantie prend effet à compter de la date d'achat du produit par le consommateur.
2. Durant cette période, Poalgi prendra à sa charge tout défaut de fabrication, casse pour variations thermiques ou irrégularités du matériel. Sont exempts de cette garantie: les casses faisant suite à un impact important ou la détérioration du matériel provoquée par une utilisation inappropriée, une installation incorrecte, réparations non autorisées, applications de produits corrosifs.
3. Poalgi se chargera de réparer ou de remplacer l'évier par le biais de l'établissement vendeur (aucun avoir ne sera réalisé). Le client devra apporter les informations relatives à l'évier et même les photos de qualité pour que notre département technique puisse vérifier et déterminer que le produit est bien couvert par la garantie.

La prise en charge sous garantie se limite à la réparation appropriée du produit ou remplacement de la pièce défectueuse, reconnue par le département de contrôle qualité ; les frais engendrés par la nouvelle installation ne sont pas pris en charge par la garantie, l'acheteur ne pouvant, sous aucune condition, demander l'indemnisation pour tout dommage occasionné, directement ou indirectement.

Aucun échange ni renvoi de marchandises ne seront admis.



# Información comercial

\_ Comercial Information \_ Information commerciale

**Condiciones** Terms Termes

---

## **PRECIOS** \_PRICES \_PRIX

Los precios de esta tarifa son sin IVA y expresados en Euro (€). La empresa tiene la facultad de modificar precios, condiciones generales de venta y producto, sin la obligación de notificarlo con previo aviso.

The prices in this price list are exclusive of VAT and expressed in Euro. The company has the right to modify prices, general conditions of sale and products, without the obligation to give prior notice.

Les prix de ce tarif sont hors taxe y exprimés en Euro. La société peut modifier les prix, les conditions générales de vente et produit, sans obligation de le notifier préalablement.

## **PEDIDOS** \_ORDERS \_COMMANDES

Los pedidos han de ser aceptados por la Empresa y está supeditados a las condiciones de venta acordadas, precios y condiciones vigentes a la fecha del pedido. Los pedidos y modificación de los mismos, deben ser comunicados por escrito. No se aceptan anulaciones de pedidos, sin la aceptación por parte de Poalgi.

Orders must be accepted by the Company and are subject to the agreed terms of sale, prices and conditions in force at the date of the order. Orders and modifications to orders must be communicated in writing. No cancellations of orders will be accepted without acceptance by Poalgi.

Les commandes doivent être acceptées par la société et sont soumis aux conditions de vente convenues, aux prix et aux conditions en vigueur à la date de la commande. Les commandes et les modifications doivent être communiquées par écrit. Les annulations de commandes ne sont pas acceptées sans l'acceptation de Poalgi.

## **PORTES** \_POSTAGE \_FRAIS DE PORT

Gastos de envío no incluidos. Por favor, consultar para envío a cada país.

Delivery costs not included. Please consult for each country.

Frais de port non inclus. Merci de nous consulter pour envoi dans chaque pays.

## **PLAZOS DE ENTREGA** \_DELIVERY TIMES \_DÉLAIS DE LIVRAISON

Con la recepción del pedido, la empresa emite una confirmación de pedido vía mail con la fecha de expedición que supone la fecha en la cual la mercancía sale de nuestras instalaciones.

On receipt of the order, the company issues an order confirmation by e-mail with a dispatch date, which is the date on which the goods leave our premises.

A réception de la commande, la société émet une confirmation de commande par mail avec date d'expédition qui suppose la date à laquelle la marchandise quittera nos installations.

## **DATOS DEL CLIENTE** \_CUSTOMER DATA \_DONNÉES DU CLIENT

El cliente es responsable de todos los datos de identificación proporcionados a Poalgi, S.L. Los datos del cliente de acuerdo a la ley 675/95, serán guardados y utilizados para el cumplimiento de las obligaciones legales. Cualquier otro uso deberá ser expresamente aceptados por el cliente.

The customer is responsible for all identification data provided to Poalgi S.L. Customer data in accordance with law 675/95, will be stored and used for the fulfilment of legal obligations. Any other use must be expressly accepted by the client.

Le client est responsable de toutes les données d'identification fournies à Poalgi S.L. Les données du client conformément à la loi 675/95, seront enregistrées et utilisées pour le respect des obligations légales. Toute autre utilisation doit être expressément acceptée par le client.

## **CONDICIONES DE ENTREGA** \_CONDITIONS OF DELIVERY \_CONDITIONS DE LIVRAISON

Corresponde al destinatario la obligación de controlar y verificar la mercancía a la recepción de la misma. En caso de daños, todas las

reclamaciones se deben hacer por escrito y en un plazo máximo de 24 horas. Pasado ese plazo, la empresa no puede hacerse cargo de la mercancía dañada. Se debe aportar imagen del material deteriorado, así como copia del albarán de entrega o en su defecto justificante de envío de la agencia.

The consignee is responsible for checking and verifying the goods upon receipt of the goods. In case of damage, all claims must be made in writing and within 24 hours at the latest. After this period, the company cannot take responsibility for the damaged goods. An image of the damaged material must be provided, as well as a copy of the delivery note or, failing that, proof of dispatch from the agency.

Le destinataire est tenu de contrôler et de vérifier la marchandise à la réception de celle-ci. En cas de dommages, toutes les réclamations devront être faites par écrit et dans un délai maximal de 24 heures. Au-delà de ce délai, l'entreprise ne pourra reprendre la marchandise endommagée. Une photographie du matériel détérioré devra être fournie, ainsi que la copie du bon de livraison ou, à défaut, la preuve de l'envoi de l'agence.

### **CONDICIONES DE PAGO \_TERMS OF PAYMENT \_CONDITIONS DE PAIEMENT**

Las condiciones de pago son obligatorias. No se aceptarán cambios que no hayan sido aceptados por Poalgi, S.L. La falta de pago implicará la inclusión de los intereses bancarios que se aplicarán desde el día siguiente a la fecha de vencimiento por la deuda. La falta de pago en los términos acordados, implicará la suspensión de todos los pedidos en cartera sin previo aviso.

The payment conditions are mandatory. Changes that have not been accepted by Poalgi, S.L. will not be accepted. Failure to pay will imply the inclusion of bank interest that will be applied from the day following the due date for the debt. Failure to pay in the agreed terms will imply the suspension of all orders in the order book without prior notice.

Les conditions de paiement sont obligatoires. Les changements non acceptés par Poalgi, S.L. seront refusés. Le défaut de paiement impliquera l'ajout d'intérêts bancaires qui seront appliqués à partir du jour suivant la date d'échéance de la dette. Le non-paiement dans les termes convenus entraînera la suspension de toutes les commandes en portefeuille sans préavis.

### **RESERVA DE PROPIEDAD \_RESERVATION OF OWNERSHIP \_RÉSERVE DE PROPRIÉTÉ**

Hasta el momento en que Poalgi no haya recibido el pago total de la mercancía, esta será propiedad exclusiva de Poalgi.

Until such time as Poalgi has received full payment for the goods, the goods shall remain the exclusive property of Poalgi.

Toute commande restera la propriété exclusive de Poalgi, jusqu'à ce que celle-ci en reçoive le paiement total.

### **RESPONSABILIDAD \_RESPONSIBILITY \_RESPONSABILITÉ**

Todos los artículos de nuestra producción son cuidadosamente controlados. Los daños causados por una instalación inadecuada o mal uso no están cubiertos por la garantía. No se aceptan devoluciones de mercancía sin autorización. En cualquier caso, los costes de transporte y posibles deterioros del embalaje son por parte del cliente. En caso de materiales defectuosos, nuestra responsabilidad se limita a la sustitución de piezas que resulten defectuosas, sin compensación alguna para instalación o por cualquier daño ocasionado.

All items of our production are carefully controlled. Damage caused by improper installation or misuse is not covered by warranty. Returns of goods without authorisation are not accepted. In any case, transport costs and possible damage to packaging are the responsibility of the customer. In case of defective materials, our liability is limited to the replacement of defective parts, without any compensation for installation or for any damage caused.

Tous les articles de notre production sont soigneusement contrôlés. Les dommages causés par une installation inappropriée ou une mauvaise utilisation ne sont pas couverts par la garantie. Aucun retour de marchandise sans autorisation ne sera accepté. En tout état de cause, les coûts de transport et les éventuelles détériorations de l'emballage sont à charge du client. En cas de matériaux défectueux, notre responsabilité se limite au remplacement de pièces défectueuses, sans compensation pour l'installation ou pour tout dommage occasionné.

# Clasificación por mueble

\_ Classification by furniture  
\_ Classification par taille de meuble

40 cm 15<sup>3</sup>/<sub>4</sub> in

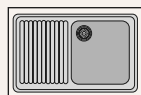

117\_SILEX

45 cm 17<sup>4</sup>/<sub>3</sub>/<sub>60</sub> in

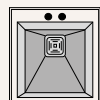

811/821\_KOBUS

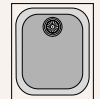

162/192\_GANDIA



152\_AMBAR (sobre encimera)



153\_TOBA

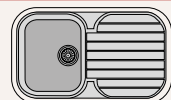

121\_CORAL

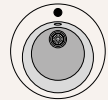

104\_ZAFIRO

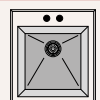

501\_SHIRA (sobre encimera)

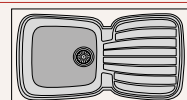

120\_OLIVINO

50 cm 19<sup>3</sup>/<sub>7</sub>/<sub>54</sub> in

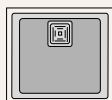

171/181\_Zie (sobre encimera)

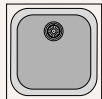

163/193\_GANDIA

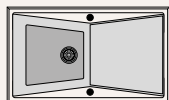

303\_KUMA

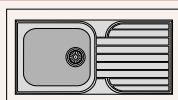

116\_TOPACIO

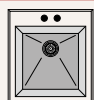

501\_SHIRA (bajo encimera)

60 cm 23<sup>2</sup>/<sub>8</sub>/<sub>45</sub> in

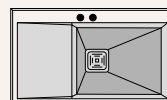

813/823\_KOBUS

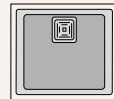

171/181\_ZIE (bajo encimera)

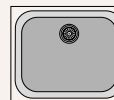

164/194\_GANDIA



320/330\_CITY



301\_KUMA

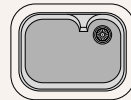

105\_RUBI

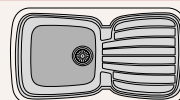

106\_DIAMANTE

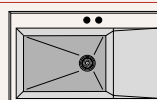

503\_SHIRA



176/186\_ZIE



152\_AMBAR (bajo encimera)

70 cm 27<sup>5</sup>/<sub>2</sub>/<sub>93</sub> in

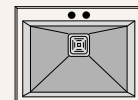

812/822\_KOBUS

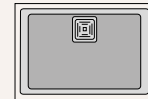

172/182\_ZIE

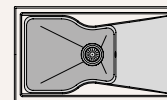

321/331\_CITY

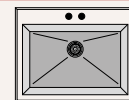

502\_SHIRA

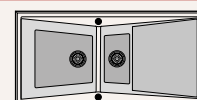

305\_KUMA

80 cm 31<sup>1</sup>/<sub>2</sub> in

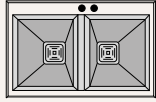

816/826\_KOBUS



173/183\_ZIE

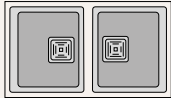

174/184\_ZIE



177/187\_ZIE

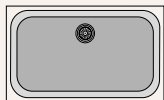

165/195\_GANDIA

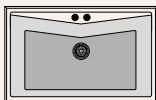

302\_KUMA

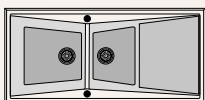

306\_KUMA

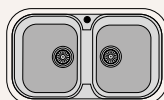

107\_ESMERALDA

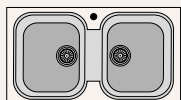

119\_AMATISTA/108\_MALAQUITA

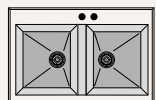

506\_SHIRA (sobre encimera)



103\_CUARZO

90 cm 35<sup>13</sup>/<sub>30</sub> in

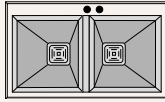

814/824\_KOBUS



175/185\_ZIE

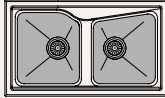

322/332\_CITY

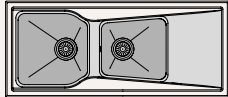

323/333\_CITY

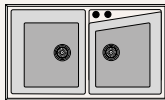

304\_KUMA

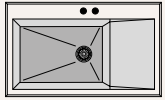

503\_SHIRA (bajo encimera)

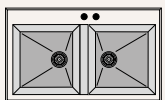

504\_SHIRA

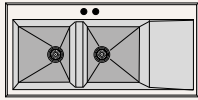

507\_SHIRA (sobre encimera)

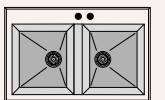

506\_SHIRA (bajo encimera)

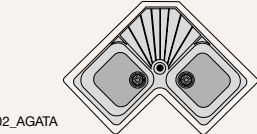

102\_AGATA

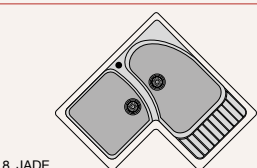

118\_JADE

100 cm 39<sup>10</sup>/<sub>27</sub> in

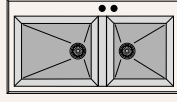

505\_SHIRA

120 cm 47<sup>21</sup>/<sub>86</sub> in

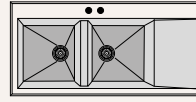

507\_SHIRA (bajo encimera)



# Tabla resumen

\_ Summary table \_ Tableau récapitulatif

COLECCIÓN COLLECTION	REFERENCIA REFERENCE		COLOCACIÓN INSTALLATION		MUEBLE FURNITURE	
	Gloss	Soft / Hekla	Sobre Inset	Bajo Undermount	Sobre Inset	Bajo Undermount
Kobus		811 - 821	●		45 cm	
Kobus		812 - 822	●		70 cm	
Kobus		813D/I - 823D/I	●		60 cm	
Kobus		814 - 824	●		90 cm	
Kobus		816 - 826	●		80 cm	
Zie	171	181	●	●	50 cm	60 cm
Zie	176	186	●	●	60 cm	60 cm
Zie	172	182	●	●	70 cm	70 cm
Zie	177	187	●	●	80 cm	80 cm
Zie	173	183	●	●	80 cm	80 cm
Zie	174	184	●	●	80 cm	80 cm
Zie	175	185	●	●	90 cm	90 cm
Gandia	161		●	●		
Gandia	162	192	●	●	45 cm	45 cm
Gandia	163	193	●	●	50 cm	50 cm
Gandia	164	194	●	●	60 cm	60 cm
Gandia	165	195	●	●	80 cm	80 cm
City	320	330	●		60 cm	
City	321	331	●		70 cm	
City	322	332	●		90 cm	
City	323	333	●		90 cm	
Shira	501		●	●	45 cm	50 cm
Shira	502		●	●	70 cm	70 cm
Shira	503D/I		●	●	60 cm	90 cm
Shira	504		●	●	90 cm	90 cm
Shira	505		●	●	100 cm	100 cm
Shira	506		●	●	80 cm	90 cm
Shira	507D/I		●	●	90 cm	120 cm
Kuma	301		●		60 cm	
Kuma	302		●		80 cm	
Kuma	303		●		50 cm	
Kuma	304		●		90 cm	
Kuma	305		●		70 cm	
Kuma	306		●		80 cm	
Basic_Ámbar	152		●	●	45 cm	60 cm
Basic_Toba	153		●		45 cm	
Basic_Rubí	105		●		60 cm	
Basic_Coral	121		●		45 cm	
Basic_Esmeralda	107		●		80 cm	
Basic_Amatista	119		●		80 cm	
Basic_Malaquita	108		●		80 cm	
Basic_Topacio	116		●		50 cm	
Basic_Olivino	120		●		45 cm	
Basic_Diamante	106		●		60 cm	
Basic_Ágata	102		●		90x90 cm	
Basic_Jade	118		●		90x90 cm	
Basic_Zafiro	104		●		45 cm	
Basic_Sílex	117		●		40 cm	
Basic_Cuarzo	103		●		80 cm	

ESPECIFICACIONES SPECIFICATIONS			TARIFA GLOSS PRICE GLOSS		TARIFA SOFT PRICE SOFT		TARIFA HEKLA® PRICE HEKLA®
Válvula Valve	Barra Anchor Bar	Orificio Hole	Colorstandard	Colorplus	Colorstandard	Colorplus	
POA315A		●					340 €
POA315A		●					380 €
POA315A		●					415 €
POA325A		●					505 €
POA325A		●					470 €
POA005SA	●		275 €	330 €	315 €	385 €	315 €
POA005SA	●		285 €	345 €	325 €	395 €	325 €
POA005SA	●		305 €	370 €	345 €	420 €	345 €
POA005SA	●		315 €	385 €	365 €	440 €	365€
POA021SA	●		350 €	430 €	400 €	490 €	400 €
POA021SA	●		375 €	460 €	425 €	520 €	420 €
POA005SA	●		375 €	460 €	425 €	520 €	420 €
330MT	●		105 €	125 €			
330MT	●		200 €	240 €	235 €	280 €	230 €
330MT	●		210 €	255 €	245 €	295 €	240 €
330MT	●		255 €	310 €	295 €	355 €	295 €
330MT	●		295 €	365 €	345 €	415 €	340 €
POA030		●	200 €	250 €	235 €	285 €	235 €
POA030		●	240 €	295 €	270 €	330 €	270 €
POA027		●	295 €	365 €	340 €	415 €	340 €
POA027		●	335 €	410 €	385 €	475 €	385 €
POA030		●	270 €	320 €			
POA030		●	315 €	365 €			
POA030		●	360 €	390 €			
POA027		●	405 €	445 €			
POA027		●	455 €	490 €			
POA027		●	360 €	405 €			
POA027		●	470 €	540 €			
POA030		●	295 €	365 €			
POA030		●	340 €	415 €			
POA030		●	335 €	410 €			
POA027		●	395 €	490 €			
POA027		●	420 €	520 €			
POA027		●	470 €	580 €			
330MT			155 €	190 €			
330MT		●	170 €	210 €			
330MT		●	195 €	235 €			
330MT			205 €	255 €			
350MT		●	230 €	280 €			
350MT		●	230 €	280 €			
350MT		●	230 €	280 €			
330MT			210 €	255 €			
330MT			205 €	255 €			
330MT			240 €	295 €			
350MT		●	305 €	375 €			
350MT		●	305 €	375 €			
330MT		●	155 €	190 €			
310			145 €	170 €			
310			255 €	275 €			

# Créditos

\_ Credits \_ Crédits

## Countertops

### Neolith

Artic White  
Zaha Stone  
Retro Stone  
New York New York  
Aorio  
Nero  
Just White

### Compac Surfaces

Unique Calacatta  
Unique Marquina  
Nocturo  
Unique Argento  
Petra White River  
Cobweb

## Furniture

Magama

## Taps

Nobili

## Locations

Fabrika 12  
Casa Bueno - Chiralt Arquitectos  
Espacio Palm  
Casa del Batlle - Gradolí & Sanz Arquitectes  
Loft Natural - Spathios  
Estudio Nave con Luz Natural - Spathios

**Creative Direction and Design**

Poalgi Marketing Department

**Photography**

Contraplà  
Mimus Comunicació

**Art Direction**

Irene Chirat

**Printing**

Gráficas Torres  
July 2021

**Thanks to**

Mármoles Marbresan  
Bleda y Rosa  
David Radu



P.I. Ciutat de Carlet  
C/ Xaloc 11  
46240 CARLET  
Valencia - España

T. 962 55 82 56  
E. [comercial@poalgi.es](mailto:comercial@poalgi.es)  
[www.poalgi.es](http://www.poalgi.es)